

GENERAL CATALOGUE

LONSEAL FLOORING



VOL.4



LONSEAL FLOORING VOL. 4

INDEX

FUNCTION		P.2
	LONLEUM PLAIN	P.6
	LONLEUM MARBLE	P.8
BASIC	LONLEUM NATURAL	P.10
	LON MOKU	P.12
	ELBOUL	P.14
HIGH DURABILITY ANTIVIRAL	LONPROTECT MARBLE	P.16
	LONPROTECT MOKU	P.18
	LONPROTECT INLAID	P.20
	LONLEUM PLAIN CT	P.22
	LONLEUM MARBLE CT	P.24
	LON MOKU CT	P.26
	LONPALETTE CT	P.28
ANTIVIRAL COATING	LONLEUM COORDY CT	P.30
	LONPATIO CT	P.32
	LONLEUM RAMIE CT	P.34
	LONLEUM OPSER CT	P.36
	LONLEUM SOMMEIL CT	P.38
	LONLEUM WOODY CT	P.40
SPECIAL COATING	SANITALEUM	P.42
SHOCK ABSORBING & ANTIVIRAL	LONFOAM SELENA CT	P.44
	LONFOAM MOKU CT	P.46
	LONSAFE SHEET	P.48
	LONLAID AS	P.49
SLIP RESISTANT	LONLAID AS COMFORT	P.50
	LONMAT ME DIAMOND	P.51
	LONMAT ME HOLZWOOD	P.52
	LONMAT ME PASELAT	P.54
	LONMAT ME ROZETA	P.56
OUTDOOR	LONMAT ME SCORE	P.58
	LONMAT ME TWILL II	P.60
	LONMAT ME JASPER	P.61
	LONMAT ME RESTARIA HS	P.62
	LONMAT ME RESTARIA SB	P.63
	LONSTEP ME FZK EMOSS TYPE	P.64
STEP	LONSTEP ME FZK FLAT TYPE	P.65
	LONSTAC R	P.66
	FA STAC R	P.67
FUNCTIONAL	CD LEUM R	P.68
	TCDR	P.69
	ANTI CHEMICAL SUPERLEUM	P.70
	LONTILE OA MERAVYWOOD CT	P.72
LOOSE LAY TILES	LONTILE OA IDEASTONE CT	P.74
	LONWALL GUARD L	P.76
	LONWALL GUARD SP	P.78
	PIRICAMALL S	P.80
	PIRICAMALL S ACCESSORY	P.81
OTHERS	TRIM BELT M	P.82
	CORNER GUARD S	P.83
	LONSOFT SKIRTING BOARD	P.84
	LONSKIRTING BOARD WOODY	P.85
	WIDE SKIRTING BOARD PLAIN	P.86
	WIDE SKIRTING BOARD WOODY	P.87

FUNCTIONS

	Product Name	Page	Antiviral	Anti bacterial	Antifungal	Antifouling coating
						
BASIC	LONLEUM PLAIN	6		●		
	LONLEUM MARBLE	8		●		
	LONLEUM NATURAL	10		●		
	LON MOKU	12		●		
	ELBOUL	14		●		
HIGH DURABILITY ANTIVIRAL	LONPROTECT MARBLE	16	●	●		●
	LONPROTECT MOKU	18	●	●		●
	LONPROTECT INLAID	20	●	●		●
ANTIVIRAL COATING	LONLEUM PLAIN CT	22	●	●		●
	LONLEUM MARBLE CT	24	●	●		●
	LON MOKU CT	26	●	●		●
	LONPALETTE CT	28	●	●		●
	LONLEUM COORDY CT	30	●	●		●
	LONPATIO CT	32	●	●		●
	LONLEUM RAMIE CT	34	●	●		●
	LONLEUM OPSER CT	36	●	●		●
	LONLEUM SOMMEIL CT	38	●	●		●
	LONLEUM WOODY CT	40	●	●		●
SPECIAL COATING	SANITALEUM	42	●	●	●	●
SHOCK ABSORBING & ANTIVIRAL	LONFOAM SELENA CT	44	●	●	●	●
	LONFOAM MOKU CT	46	●	●	●	●
	LONSAFE SHEET	48				
SLIP RESISTANT	LONLAID AS	49		●	●	
	LONLAID AS COMFORT	50		●		
	LONMAT ME DIAMOND	51		●		
OUTDOOR	LONMAT ME HOLZWOOD	52				
	LONMAT ME PASELAT	54				
	LONMAT ME ROZETA	56				
	LONMAT ME SCORE	58				
	LONMAT ME TWILL II	60				
	LONMAT ME JASPER	61				
	LONMAT ME RESTARIA HS	62		●		
	LONMAT ME RESTARIA SB	63		●		
STEP	LONSTEP ME FZK EMOSS TYPE	64				
	LONSTEP ME FZK FLAT TYPE	65				
FUNCTIONAL	LONSTAC R	66		●		
	FA STAC R	67		●		
	CD LEUM R	68		●		
	TCDR	69		●		
	ANTI CHEMICAL SUPERLEUM	70		●		
LOOSE LAY TILES	LONTILE OA MERAVYWOOD CT	72				●
	LONTILE OA IDEASTONE CT	74				●

Slip resistant	Chemical resistant	Shock absorbing	Acoustic	Outdoor use	Heat barrier	Antistatic	Conductive	LOW VOC
Slip resistant	Chemical resistant	Shock absorbing	Acoustic	Outdoor use	Heat barrier	Antistatic	Conductive	LOW VOC
								•
								•
								•
								•
								•
	•							•
	•							•
	•							•
	•							•
	•							•
	•							•
	•							•
	•							•
	•							•
	•							•
	•							•
•	•							•
	•	•	•					•
	•	•	•					•
		•	•					
•								•
•								•
•								•
•				•				
•				•				
•				•				
•				•				
•				•				
•				•				
•				•				
•				•				
•				•				
•				•				
•				•				
						•		•
						•		•
							•	•
							•	•
	•					•		•
	•					•		
	•					•		

Let's take antivirus measures with Lonseal flooring!

~ Lonseal flooring is useful in various places ~

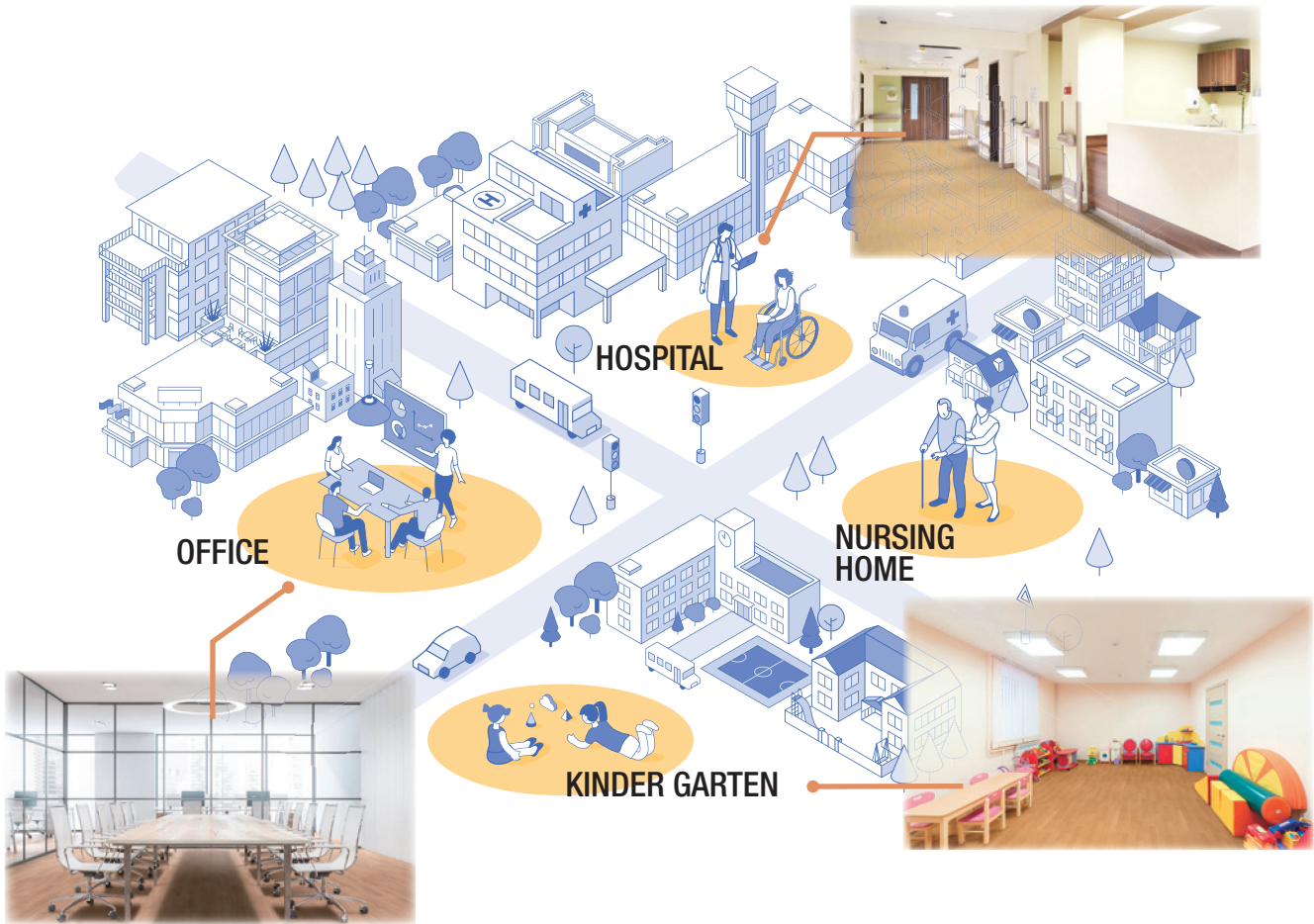

● The process of virus infection spreading

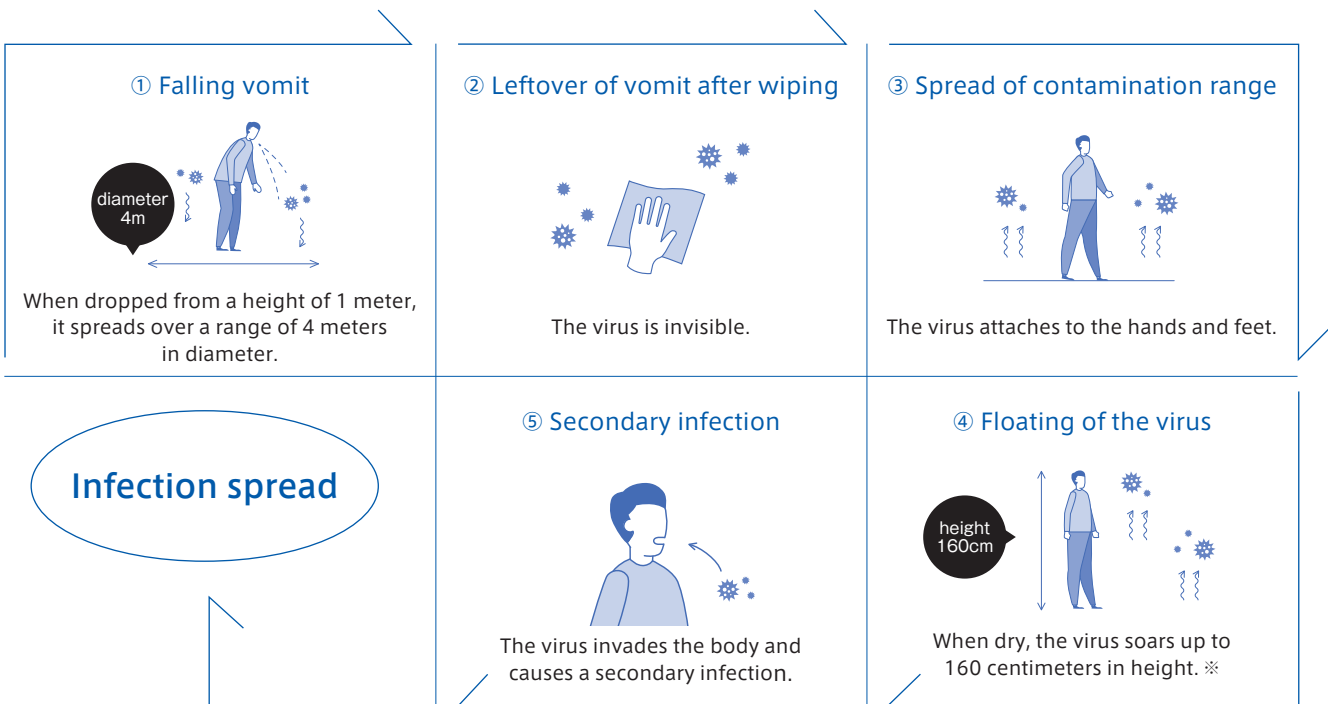

※ Quote source : Norovirus measures Emergency Task Force (Tokyo Metropolitan Institute of Public Health)

● Antiviral technology is used for the antifouling coating layer.

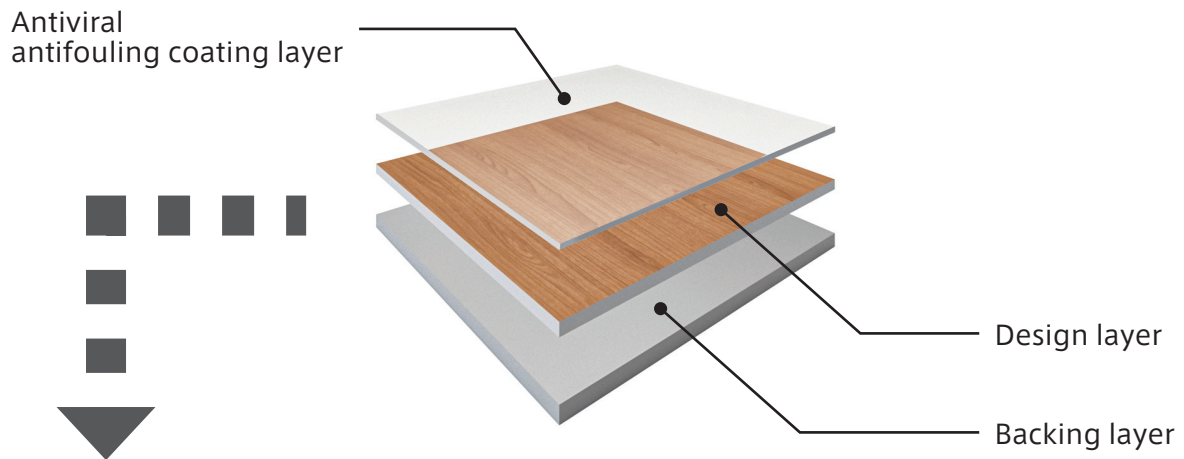

[Floor cross section]

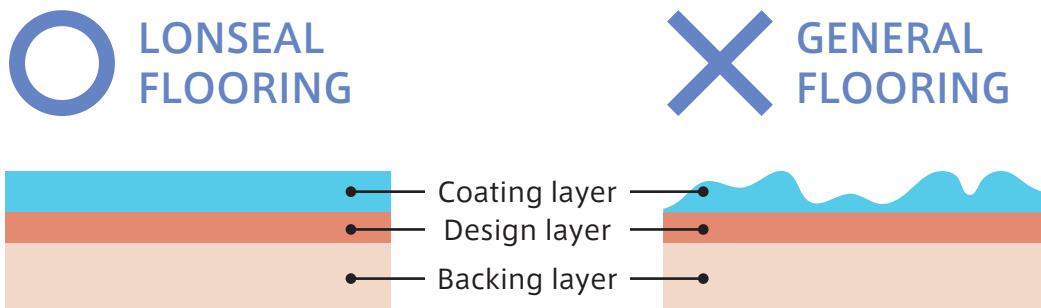

Our floor coating has a uniform layer, so you can expect the effect for a long time.

● Demonstrates 99% or more antiviral effect even after 24 hours.

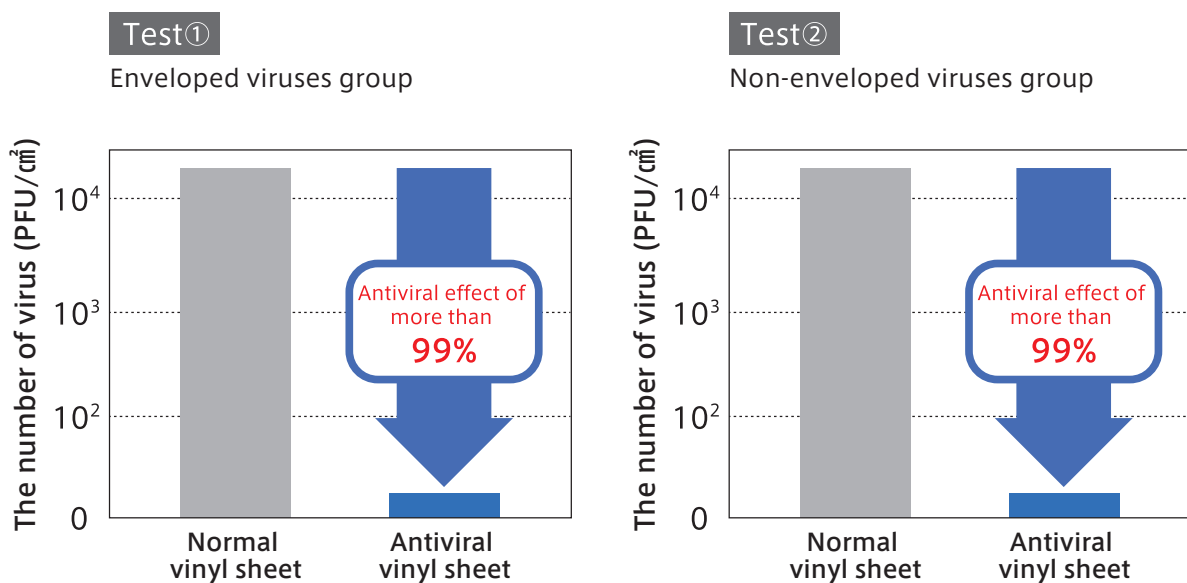

Testing institution : Japan Textile Products Quality and Technology Center

Test method : ISO21702

※The date mentioned above are examination levels and are not a guarantee level.

LONLEUM PLAIN



The simplicity of LONLEUM PLAIN can instantly upgrade the most humble interior and put a classic and elegant finishing touch on any interior commercial space.

■ Features

- It has a flexible shock absorbing surface that reduces the impact shock and leg fatigue.
- Extremely durable performance is suitable for high foot traffic areas with minimal surface layer.
- Protective surface has excellent chemical resistance such as acid and alkaline.
- Easy to fit and install to the installation location. It requires easy and little maintenance.
- Stain resistant material.

■ Specification

General name	Vinyl floor sheet FS (JIS A 5705)
Dimensions	2.0mm (thickness) × 1,820mm (width) × 9m (length) 2.5mm (thickness) × 1,820mm (width) × 9m (length)
Number of colors	24 colors
Packaging	9m/roll
Weight	(2.0 mm) 3.3kg/m ² , 54kg/roll (2.5 mm) 4.0kg/m ² , 65kg/roll



■ Color variations

24colors

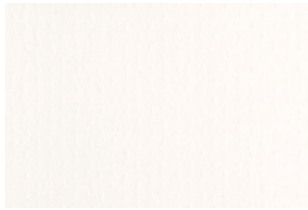

3907



3159

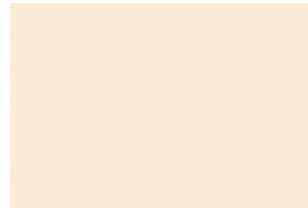

3054



3025

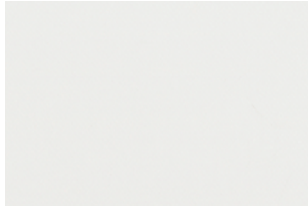

3051

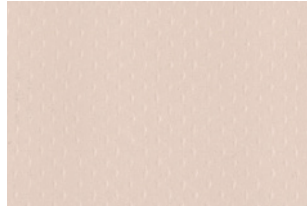

3301

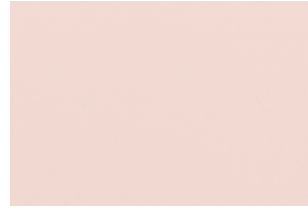

3022



3102

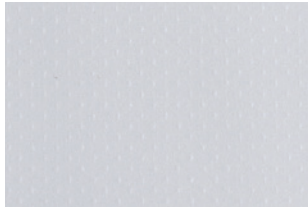

3902



3134

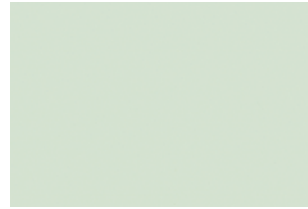

3057



3138



3140



3113

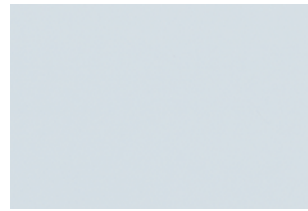

3059



3610



3116



3308



3056



3053

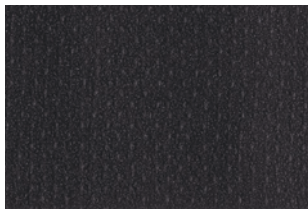

3906



3510



3058



3060

LONLEUM MARBLE



LONLEUM MARBLE captures the luxury looks and one of the most beautiful materials. Its classic design of white marbled feathery veins adds a timeless, elegant look for any commercial space.

■ Features

- It has a flexible shock absorbing surface that reduces the impact shock and leg fatigue.
- Extremely durable performance is suitable for high foot traffic areas with minimal surface layer.
- Protective surface has excellent chemical resistance such as acid and alkaline.
- Easy to fit and install to the installation location. It requires easy and little maintenance.
- Stain resistant material.

■ Specification

General name	Vinyl floor sheet FS (JIS A 5705)
Dimensions	2.0mm (thickness) × 1,820mm (width) × 9m (length) 2.5mm (thickness) × 1,820mm (width) × 9m (length)
Number of colors	28 colors
Packaging	9m/roll
Weight	(2.0 mm) 3.3kg/m ² , 54kg/roll (2.5 mm) 4.0kg/m ² , 65kg/roll



■ Color variations

28colors

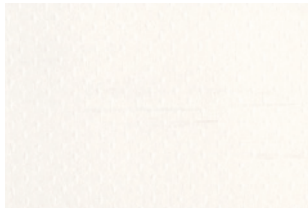

5801



5401



5026



5031



5301



5023



5102



5589



5598

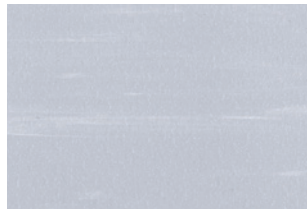

5902



5027



5119



5588



5140



5202



5613



5562



5024

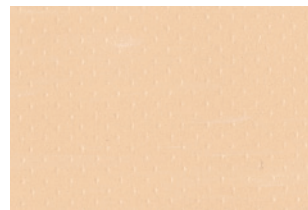

5407



5033



5307

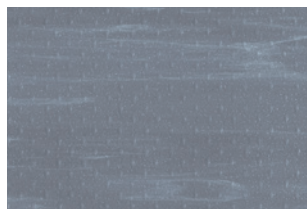

5116



5028



5612



5308

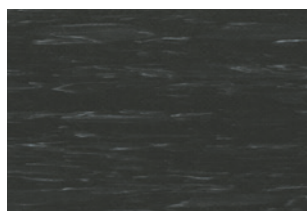

5906



5030



5029

LONLEUM NATURAL



LONLEUM NATURAL provides the beauty and realism of a natural stone face and it brings in a sense of stylish and earthy in any commercial space.

■ Features

- It has a flexible shock absorbing surface that reduces the impact shock and leg fatigue.
- Extremely durable performance is suitable for high foot traffic areas with minimal surface layer.
- Protective surface has excellent chemical resistance such as acid and alkaline.
- Easy to fit and install to the installation location. It requires easy and little maintenance.
- Stain resistant material.

■ Specification

General name	Vinyl floor sheet FS (JIS A 5705)
Dimensions	2.0mm (thickness) × 1,820mm (width) × 9m (length)
Number of colors	14 colors
Packaging	9m/roll
Weight	3.0kg/m ² , 49kg/roll



■ Color variations

14colors



NL-4001

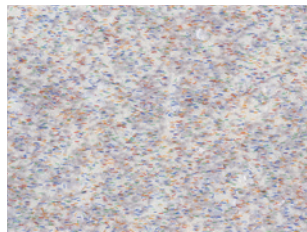

NL-4014

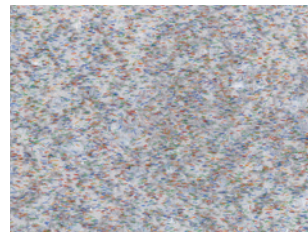

NL-4002

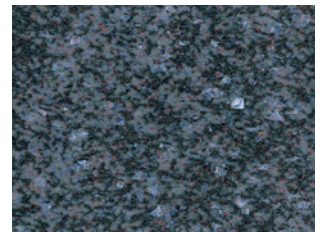

NL-4045

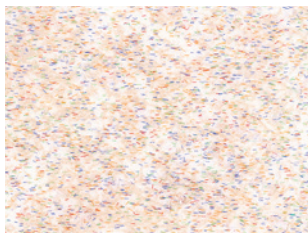

NL-4004

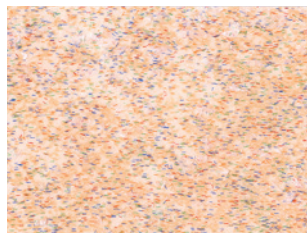

NL-4005



NL-4006

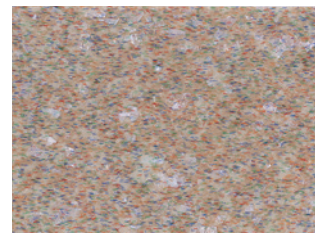

NL-4040

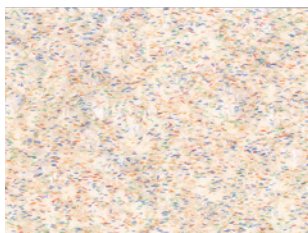

NL-4016



NL-4019



NL-4008

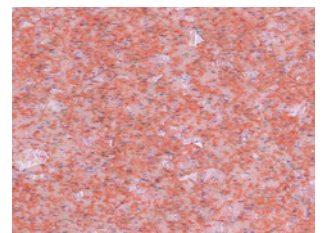

NL-4043



NL-4017



NL-4013

LON MOKU



Sometimes, the simplest looks makes the largest selection. LON MOKU is classic wood's grain design, long-lasting and durable vinyl sheet flooring that is designed for any high traffic spaces.

■ Features

- It has a flexible shock absorbing surface that reduces the impact shock and leg fatigue.
- Extremely durable performance is suitable for high foot traffic areas with minimal surface layer.
- Protective surface has excellent chemical resistance such as acid and alkaline.
- Easy to fit and install to the installation location. It requires easy and little maintenance.
- Stain resistant material.

■ Specification

General name	Vinyl floor sheet FS (JIS A 5705)
Dimensions	2.0mm (thickness) × 1,820mm (width) × 9m (length)
Number of colors	9 colors
Packaging	9m/roll
Weight	2.9kg/m ² , 48kg/roll



■ Color variations

9colors

Oak



MK-1801



MK-1802

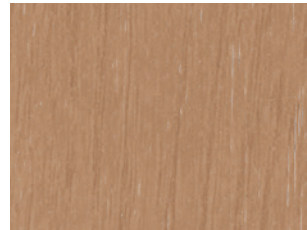

MK-1803

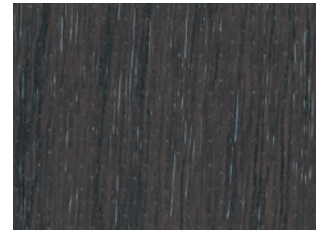

MK-1804



MK-1805

Cherry



MK-1851



MK-1852

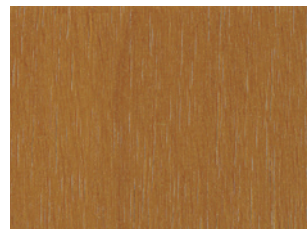

MK-1853

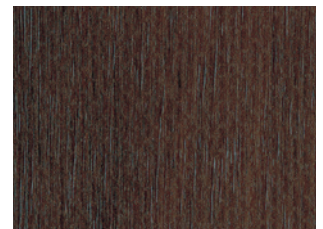

MK-1854

ELBOUL



Luxury vinyl sheet flooring has a glorious time with you.
Iridescent color makes ELBOUL as a fashionable sheet flooring.

■ Features

Its surface was designed to have natural materials-looking that creates a unique texture. Hues of ELBOUL is changed the color depending on the angle from which it is viewed.

■ Specification

General name	Vinyl floor sheet FS (JIS A 5705)
Dimensions	2.0mm (thickness) × 1,820mm (width) × 9m (length)
Number of colors	8 colors
Packaging	9m/roll
Weight	3.0kg/m ² , 50kg/roll



■ Color variations

8colors



4 Pearl beige



5 Light brown



6 Brown

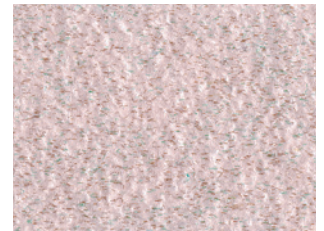

7 Pearl pink



2 Dark gray



3 Warm gray

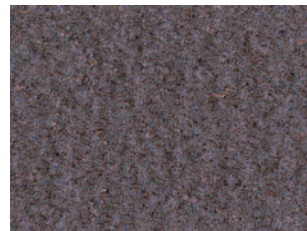

12 Purplish gray

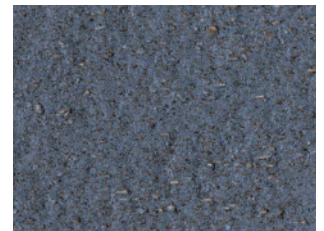

15 Blue purplish gray

LONPROTECT MARBLE

HIGH DURABILITY
ANTIVIRAL

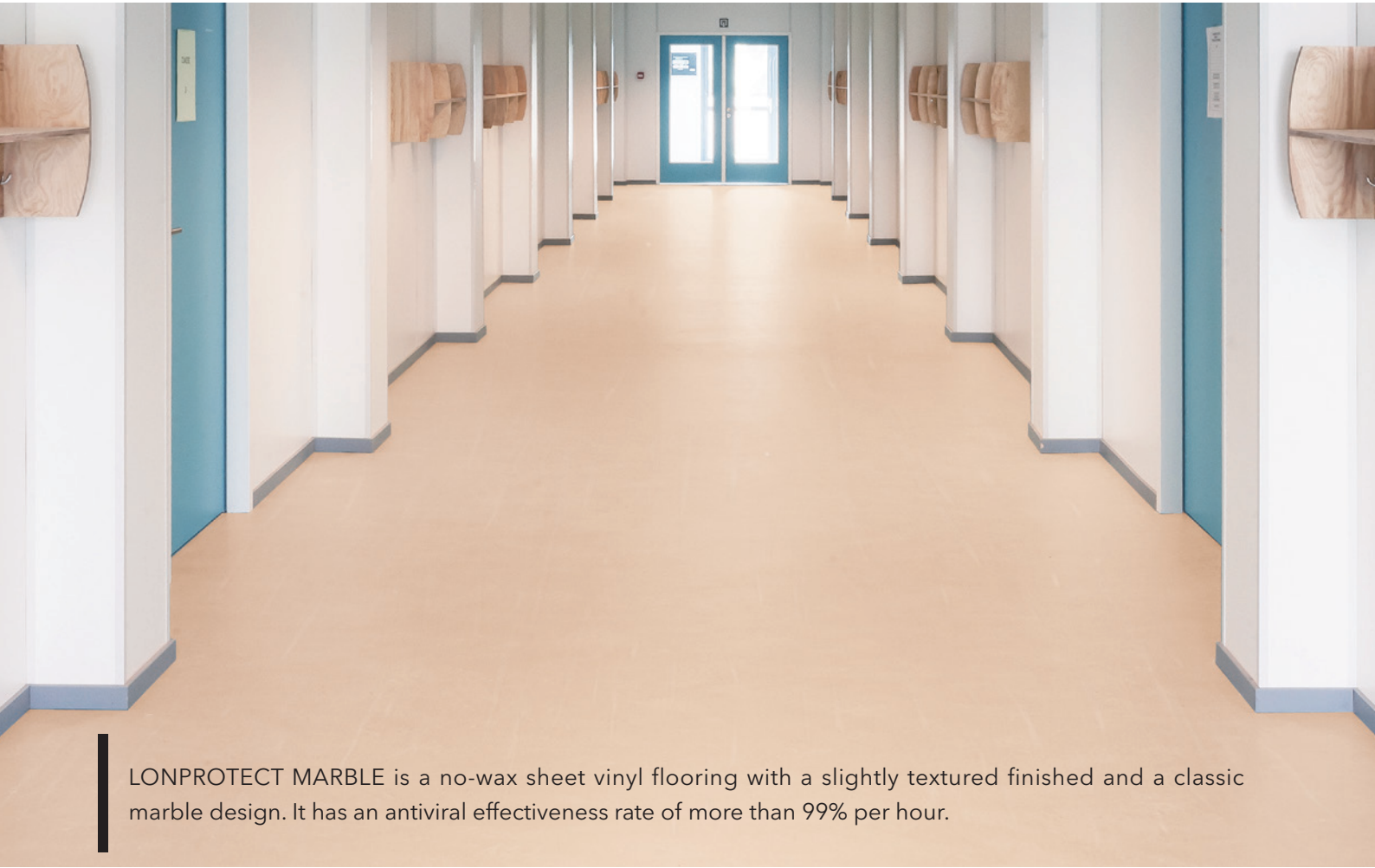

LONPROTECT MARBLE is a no-wax sheet vinyl flooring with a slightly textured finished and a classic marble design. It has an antiviral effectiveness rate of more than 99% per hour.

■ Features

- No-wax surface layer makes daily maintenance easier.
- It has a flexible shock absorbing surface that reduces the impact shock and leg fatigue.
- Extremely durable performance is suitable for high foot traffic areas with minimal surface layer.
- Protective surface has excellent chemical resistance such as acid and alkaline.
- Easy to fit and install to the installation location.
- LONPROTECT MARBLE requires easy and little maintenance.
- Stain resistant material.

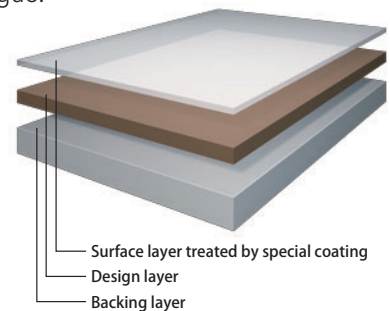

■ Specification

General name	Antiviral Vinyl floor sheet FS (JIS A 5705)
Dimensions	2.0mm (thickness) × 1,820mm (width) × 9m (length)
Number of colors	6 colors
Packaging	9m/roll
Weight	3.3kg/m ² , 54kg/roll



■ Color variations

6colors



PRA-5598



PRA-5588



PRA-5202



PRA-5105



PRA-5589

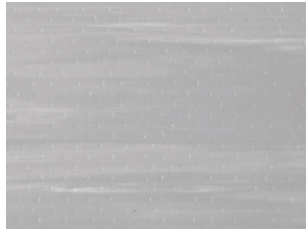

PRA-5140

Antiviral activity

In general terms, when a virus is inactivated, it disrupts its original growth cycle.

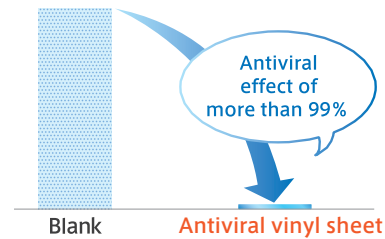
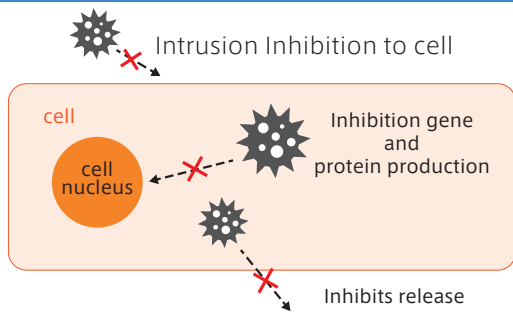

It has the performance that is very higher than a normal vinyl sheet

So many latent viruses growing in our living environment

• Recent virus-related problems

Spread of seasonal diseases

- Food poisoning problem of norovirus
- Influenza group infection

Concern of global spread of SARS coronavirus

Problem of infection of highly virulent avian influenza to human

Make every portion in facilities antiviral by the LONPROTECT technology

Using the LONPROTECT technology to various things spreads antiviral effect to walls and floors among other places where many people gather in schools, hospitals, and such.

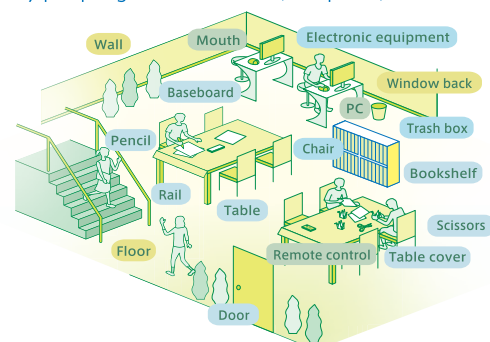

LONPROTECT MOKU

**HIGH DURABILITY
ANTIVIRAL**



LONPROTECT MOKU is a no-wax sheet vinyl flooring that gives the traditional wood design and brings style, performance and quality to any commercial space.

■ Features

- No-wax surface layer makes daily maintenance easier.
- It has a flexible shock absorbing surface that reduces the impact shock and leg fatigue.
- Protective surface has excellent chemical resistance such as acid and alkaline.
- Easy to fit and install to the installation location. It requires easy and little maintenance.

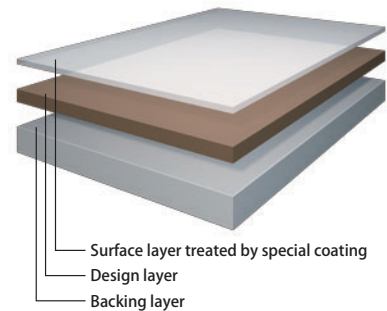

■ Specification

General name	Antiviral Vinyl floor sheet FS (JIS A 5705)
Dimensions	2.0mm (thickness) × 1,820mm (width) × 9m (length)
Number of colors	10 colors
Packaging	9m/roll
Weight	3.3kg/m ² , 54kg/roll



■ Color variations

10colors

Oak



PRM-1801



PRM-1802



PRM-1805



PRM-1807

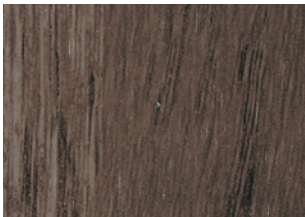

PRM-1808

Walnut



PRM-1833



PRM-1834



PRM-1837

Cherry



PRM-1851



PRM-1852

Antiviral activity

In general terms, when a virus is inactivated, it disrupts its original growth cycle.

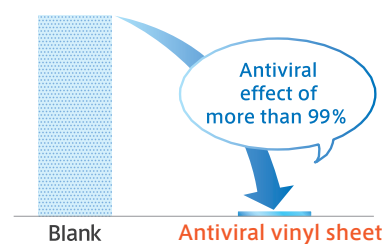
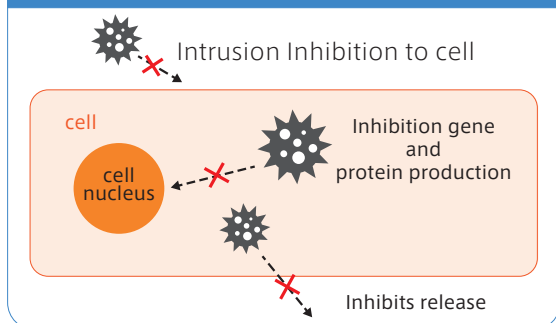

It has the performance that is very higher than a normal vinyl sheet

LONPROTECT INLAID

**HIGH DURABILITY
ANTIVIRAL**



A slightly textured finish with contrasting speckled design, LONPROTECT INLAID is a no-wax sheet vinyl flooring that has an antiviral effectiveness rate of more than 99% per hour.

■ Features

- No-wax surface layer makes daily maintenance easier.
- It has a flexible shock absorbing surface that reduces the impact shock and leg fatigue.
- Easy to fit and install to the installation location.
- It requires easy and little maintenance.

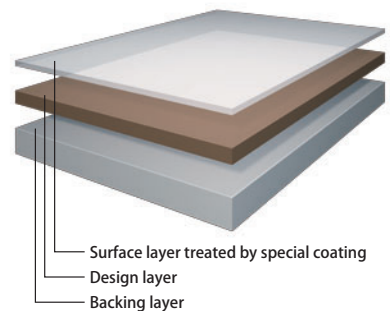

■ Specification

General name	Antiviral Vinyl floor sheet FS (JIS A 5705)
Dimensions	2.0mm (thickness) × 1,820mm (width) × 9m (length)
Number of colors	15 colors
Packaging	9m/roll
Weight	3.3kg/m ² , 54kg/roll



Color variations

15colors



PRB-2101

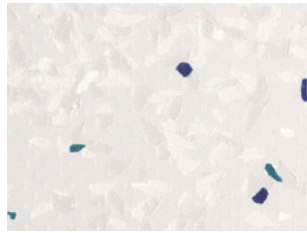

PRB-2110



PRB-2107

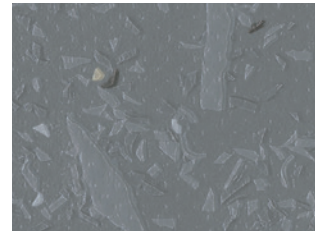

PRB-2108



PRB-2104

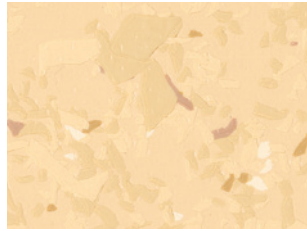

PRB-2105



PRB-2102

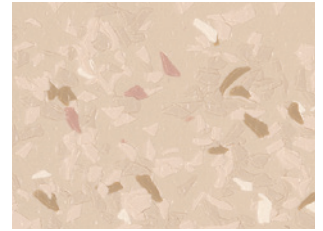

PRB-2103

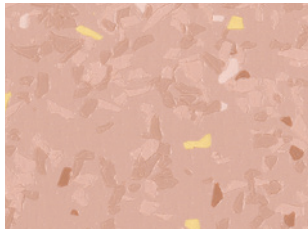

PRB-2114



PRB-2111

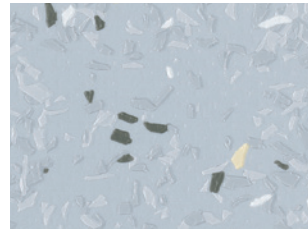

PRB-2109

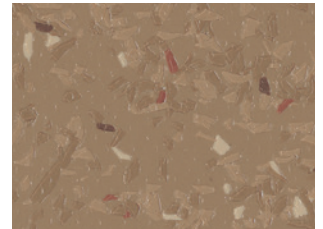

PRB-2106



PRB-2115

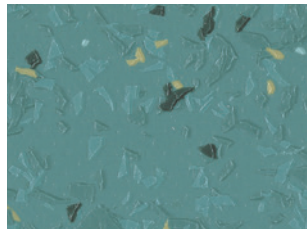

PRB-2112

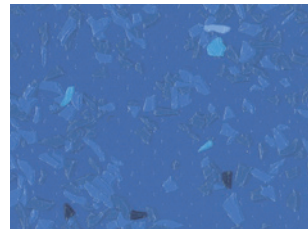

PRB-2113

Antiviral activity

In general terms, when a virus is inactivated, it disrupts its original growth cycle.

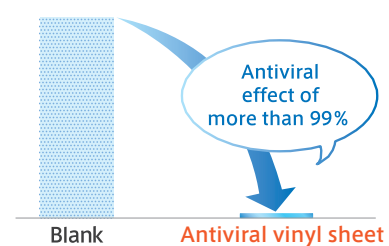
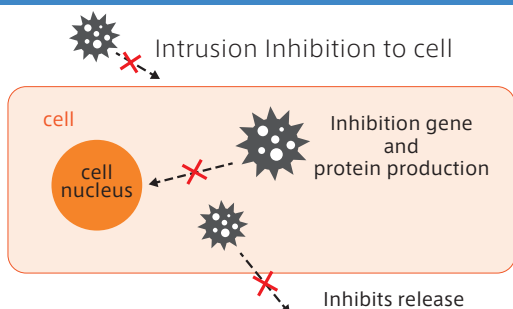

It has the performance that is very higher than a normal vinyl sheet

LONLEUM PLAIN CT ANTIVIRAL



LONLEUM PLAIN CT is a no-wax sheet vinyl flooring that can provide a neutral look and a bold modern statement. It create a never-before-seen design solution.

■ Features

- No-wax surface layer makes daily maintenance easier.
- It has a flexible shock absorbing surface that reduces the impact shock and leg fatigue.
- Extremely durable performance is suitable for high foot traffic areas with minimal surface layer.
- Protective surface has excellent chemical resistance such as acid and alkaline.
- Easy to fit and install to the installation location. It requires easy and little maintenance.
- Moisture and stain resistant material.

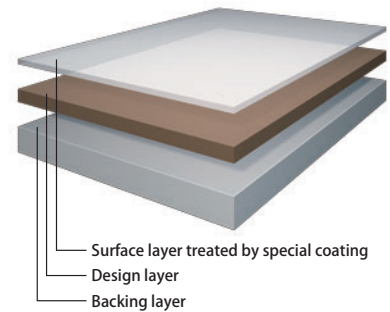

■ Specification

General name	Antiviral Vinyl floor sheet FS (JIS A 5705)
Dimensions	2.0mm (thickness) × 1,820mm (width) × 9m (length)
Number of colors	24 colors
Packaging	9m/roll
Weight	3.3kg/m ² , 54kg/roll

JIS A 5705
QA0307072

15% recycled
(Act on promoting
Green procurement)

LOW VOC

Antiviral

Anti-bacterial

Antifouling coating

Chemical resistant

**General use
(Durability)**

■ Color variations

24colors

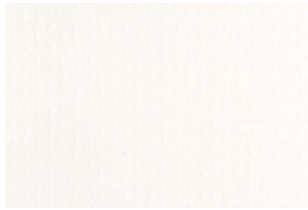

3907CT



3159CT

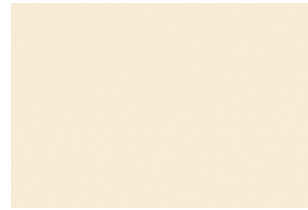

3054CT



3025CT

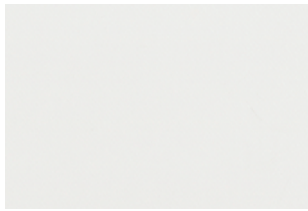

3051CT

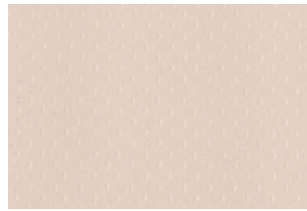

3301CT



3022CT



3102CT

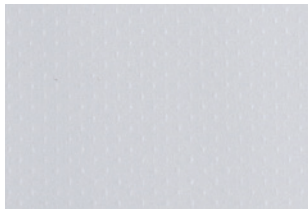

3902CT

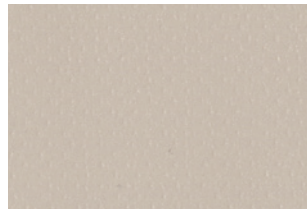

3134CT

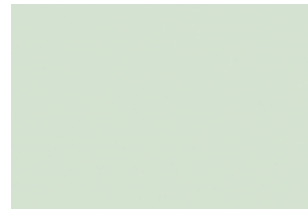

3057CT

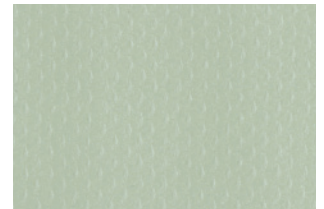

3138CT

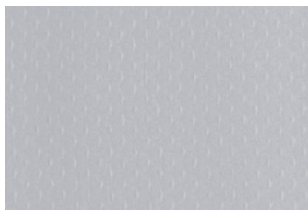

3140CT

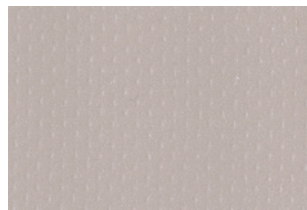

3113CT



3059CT



3610CT

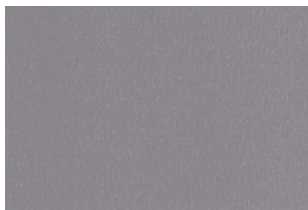

3116CT

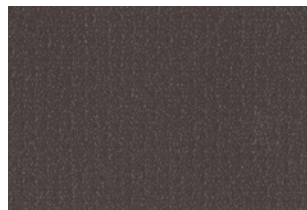

3308CT



3056CT



3053CT

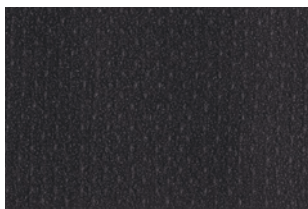

3906CT



3510CT



3058CT



3060CT

LONLEUM MARBLE CT ANTIVIRAL



An everlasting marble design, LONLEUM MARBLE CT is a no-wax sheet vinyl flooring that provides luxury elegance for any commercial space.

■ Features

- No-wax surface layer makes daily maintenance easier.
- It has a flexible shock absorbing surface that reduces the impact shock and leg fatigue.
- Extremely durable performance is suitable for high foot traffic areas with minimal surface layer.
- Protective surface has excellent chemical resistance such as acid and alkaline.
- Easy to fit and install to the installation location. It requires easy and little maintenance.
- Moisture resistant material.

■ Specification

General name	Antiviral Vinyl floor sheet FS (JIS A 5705)
Dimensions	2.0mm (thickness) × 1,820mm (width) × 9m (length)
Number of colors	28 colors
Packaging	9m/roll
Weight	3.3kg/m ² , 54kg/roll

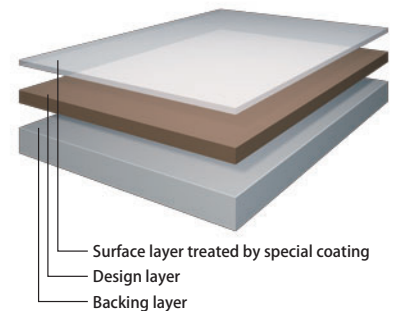



JIS A 5705
QA0307072

15% recycled
(Act on promoting
Green procurement)



LOW VOC

Antiviral

Anti-bacterial

Antifouling coating

Chemical resistant

General use (Durability)

■ Color variations

28 colors

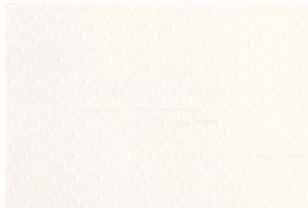

5801CT



5401CT



5026CT



5031CT



5301CT



5023CT



5102CT



5589CT



5598CT



5902CT



5027CT



5119CT



5588CT



5140CT



5202CT



5613CT



5562CT



5024CT



5407CT



5033CT



5307CT

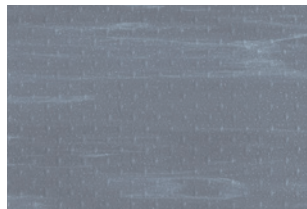

5116CT



5028CT



5612CT



5308CT

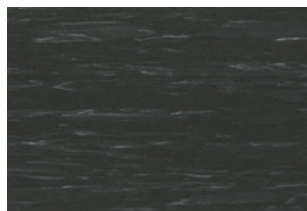

5906CT



5030CT



5029CT

LON MOKU CT ANTIVIRAL



LON MOKU CT is a no-wax sheet vinyl flooring that provides the beauty of natural wood and brings style, performance and quality to any commercial space.

■ Features

- No-wax surface layer makes daily maintenance easier.
- It has a flexible shock absorbing surface that reduces the impact shock and leg fatigue.
- Extremely durable performance is suitable for high foot traffic areas with minimal surface layer.
- Protective surface has excellent chemical resistance such as acid and alkaline.
- Easy to fit and install to the installation location. It requires easy and little maintenance.
- Moisture, stain and slip resistant material.

■ Specification

General name	Antiviral Vinyl floor sheet FS (JIS A 5705)
Dimensions	2.0mm (thickness) × 1,820mm (width) × 9m (length)
Number of colors	20 colors
Packaging	9m/roll
Weight	2.9kg/m ² , 48kg/roll

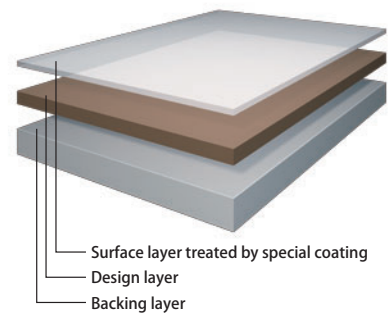

■ Color variations

20colors

Oak



MKC-1801



MKC-1802



MKC-1803



MKC-1804



MKC-1805



MKC-1806



MKC-1807

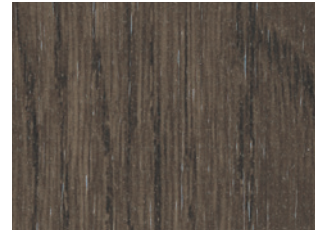

MKC-1808

Walnut



MKC-1834

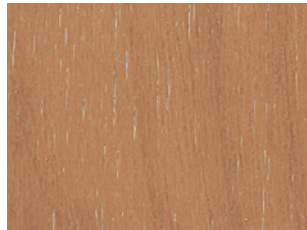

MKC-1833

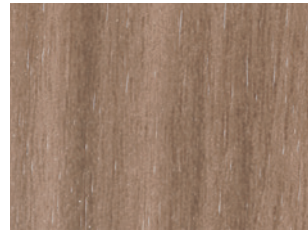

MKC-1832



MKC-1831



MKC-1838



MKC-1837



MKC-1836



MKC-1835

Cherry



MKC-1851



MKC-1852



MKC-1853

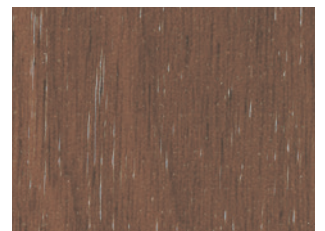

MKC-1854

LONPALETTE CT ANTIVIRAL



LONPALETTE CT is a no-wax sheet vinyl flooring that balances a subtle abstract design with functional performance that transforms the characteristics in any commercial space.

■ Features

No-wax surface layer makes daily maintenance easier.

It has a flexible shock absorbing surface that reduces the impact shock and leg fatigue.

Easy to fit and install to the installation location.

Antiviral material.

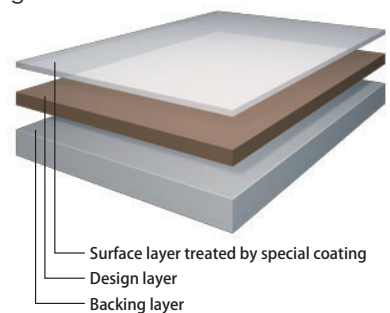

■ Specification

General name	Antiviral Vinyl floor sheet FS (JIS A 5705)
Dimensions	2.0mm (thickness) × 1,820mm (width) × 9m (length)
Number of colors	20 colors
Packaging	9m/roll
Weight	3.0kg/m ² , 49kg/roll

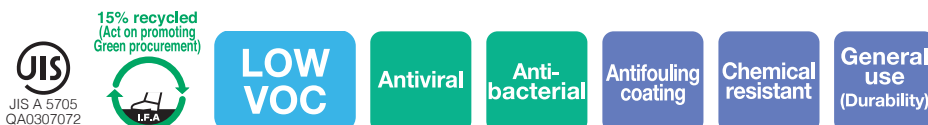

■ Color variations

20colors



LPC-1301



LPC-1306



LPC-1311



LPC-1316



LPC-1302



LPC-1307



LPC-1312



LPC-1317

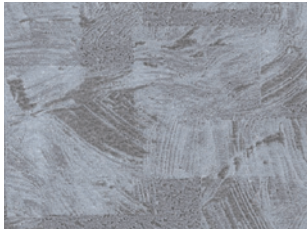

LPC-1303



LPC-1308



LPC-1313



LPC-1318



LPC-1304



LPC-1309

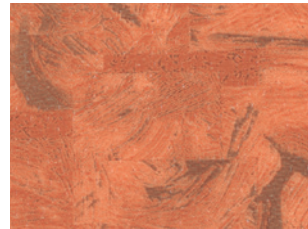

LPC-1314



LPC-1319



LPC-1305

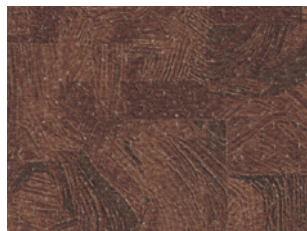

LPC-1310

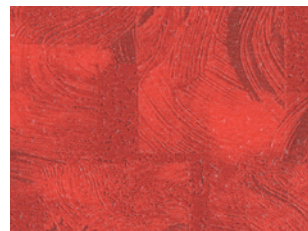

LPC-1315



LPC-1320

LONLEUM COORDY CT ANTIVIRAL



Inspired by nature, LONLEUM COORDY CT is a no-wax sheet vinyl flooring that gives a realistic stone effect that fits both modern and traditional designed environments.

■ Features

No-wax surface layer makes daily maintenance easier.

A design layer consists of a variety of color variations and designs.

It has a flexible shock absorbing surface that reduces the impact shock and leg fatigue.

Easy to fit and install to the installation location.

Protective surface has excellent chemical resistance such as acid and alkaline.

Antiviral material.

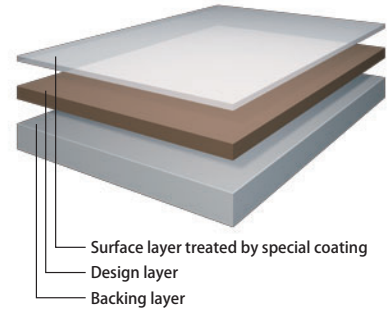

■ Specification

General name	Antiviral Vinyl floor sheet FS (JIS A 5705)
Dimensions	2.0mm (thickness) × 1,820mm (width) × 9m (length)
Number of colors	10 colors
Packaging	9m/roll
Weight	3.1kg/m ² , 51kg/roll

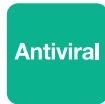

■ Color variations

10colors



COC-6201



COC-6202



COC-6211



COC-6212



COC-6221



COC-6222

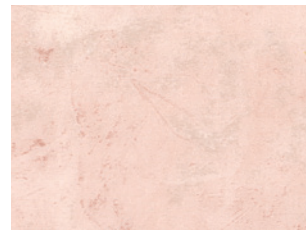

COC-6231



COC-6232

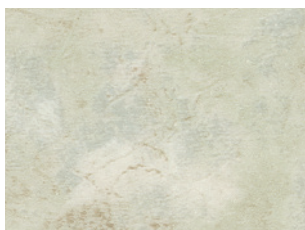

COC-6241



COC-6242

LONPATIO CT ANTIVIRAL

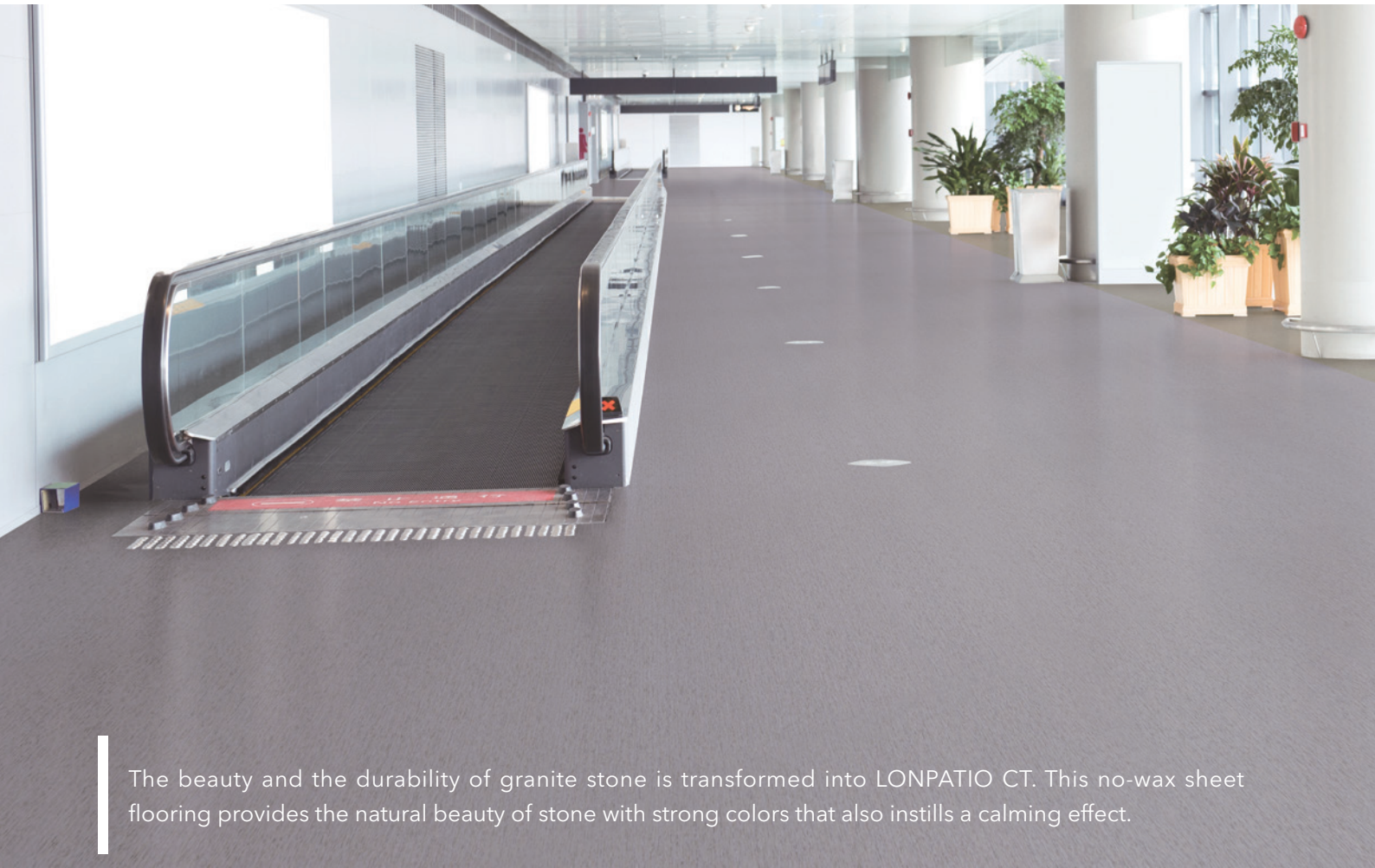

The beauty and the durability of granite stone is transformed into LONPATIO CT. This no-wax sheet flooring provides the natural beauty of stone with strong colors that also instills a calming effect.

■ Features

- No-wax surface layer makes daily maintenance easier.
- It has a flexible shock absorbing surface that reduces the impact shock and leg fatigue.
- Extremely durable performance is suitable for high foot traffic areas with minimal surface layer.
- Easy to fit and install to the installation location.
- It requires easy and little maintenance.

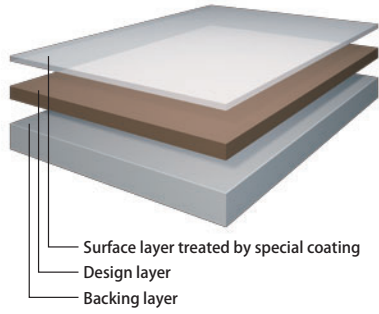

■ Specification

General name	Antiviral Vinyl floor sheet FS (JIS A 5705)
Dimensions	2.0mm (thickness) × 1,820mm (width) × 9m (length)
Number of colors	19 colors
Packaging	9m/roll
Weight	3.0kg/m ² , 49kg/roll

JIS A 5705
QA0307072

15% recycled
(Act on promoting
Green procurement)

LOW VOC

Antiviral

Anti-bacterial

Antifouling coating

Chemical resistant

General use
(Durability)

■ Color variations

19colors

Mythos



PMC-1103

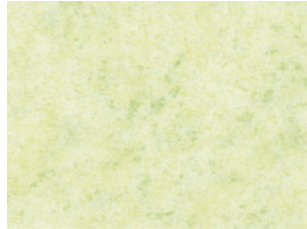

PMC-1113



PMC-1112



PMC-1111



PMC-1104

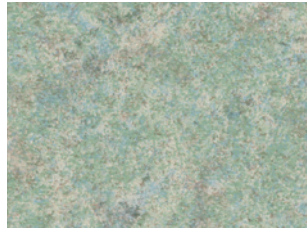

PMC-1108

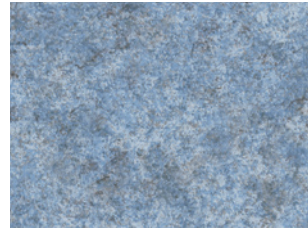

PMC-1109

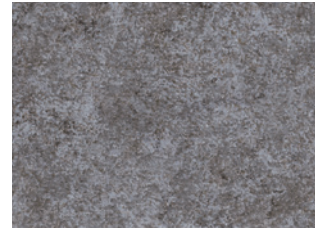

PMC-1102



PMC-1105



PMC-1107

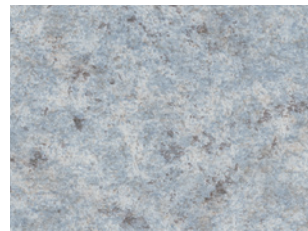

PMC-1101



PMC-1110



PMC-1106

Corinth



PCC-1201



PCC-1203

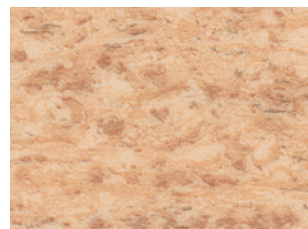

PCC-1206



PCC-1207



PCC-1202



PCC-1205

LONLEUM RAMIE CT ANTIVIRAL



Antiviral vinyl sheet with fine texture like a fabric looks.
Provide a warm atmosphere for various situations.

■ Features

No-wax surface layer makes daily maintenance easier.

A design layer consists of a variety of color variations and designs

It has a flexible shock absorbing surface that reduces the impact shock and leg fatigue.

Easy to fit and install to the installation location.

Protective surface has excellent chemical resistance such as acid and alkaline.

■ Specification

General name	Antiviral Vinyl floor sheet FS (JIS A 5705)
Dimensions	2.0mm (thickness) × 1,820mm (width) × 9m (length)
Number of colors	13 colors
Packaging	9m/roll
Weight	3.2kg/m ² , 53kg/roll

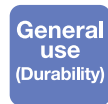
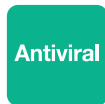
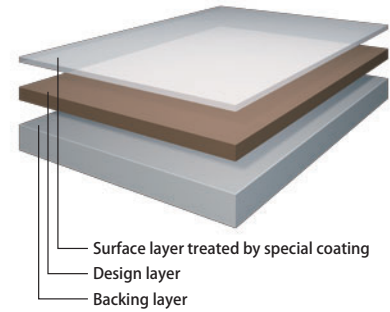

■ Color variations

13colors

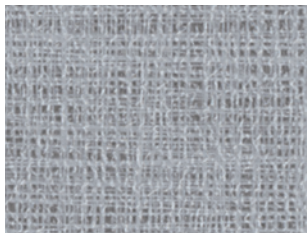

RAC-2202

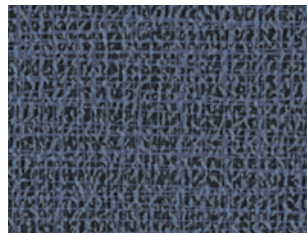

RAC-2206

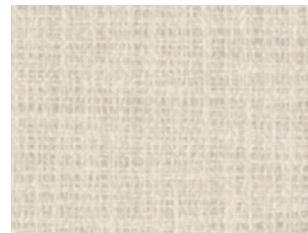

RAC-2213



RAC-2204



RAC-2201

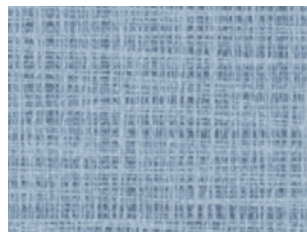

RAC-2211

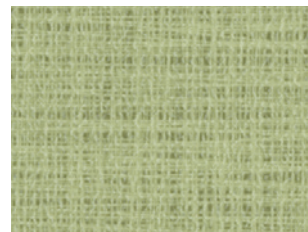

RAC-2210

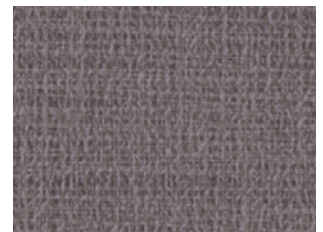

RAC-2207



RAC-2205



RAC-2209



RAC-2208



RAC-2203



RAC-2212

LONLEUM OPSER CT ANTIVIRAL



Antiviral vinyl sheet with soft and sedate texture is covered with dim light. LONLEUM OPSER CT appearance is inspired by natural stone.

■ Features

No-wax surface layer makes daily maintenance easier.

A design layer consists of a variety of color variations and designs.

It has a flexible shock absorbing surface that reduces the impact shock and leg fatigue.

Easy to fit and install to the installation location.

Protective surface has excellent chemical resistance such as acid and alkaline.

■ Specification

General name	Antiviral Vinyl floor sheet FS (JIS A 5705)
Dimensions	2.0mm (thickness) × 1,820mm (width) × 9m (length)
Number of colors	15 colors
Packaging	9m/roll
Weight	3.0kg/m ² , 49kg/roll

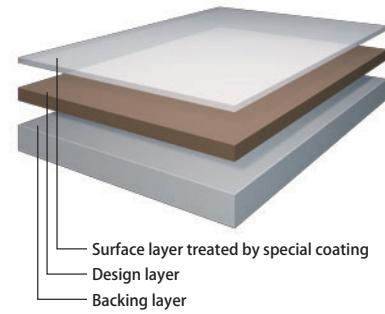

■ Color variations

15colors

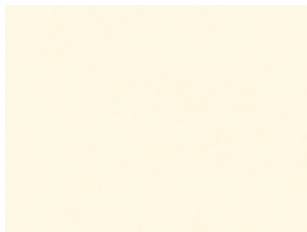

OPC-8004



OPC-8005



OPC-8006



OPC-8007



OPC-8001



OPC-8002

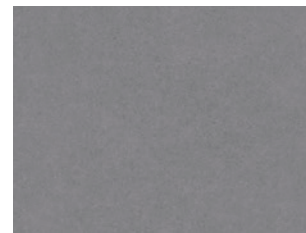

OPC-8003

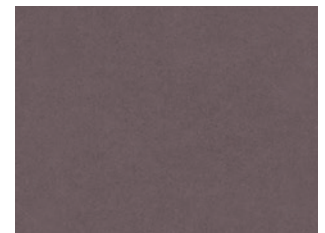

OPC-8008



OPC-8011



OPC-8009



OPC-8014



OPC-8013

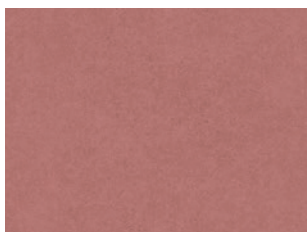

OPC-8012



OPC-8010

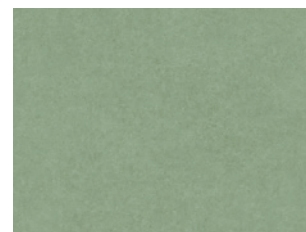

OPC-8015

LONLEUM SOMMEIL CT ANTIVIRAL



Antiviral vinyl sheet with soft and warm texture is covered with dim light.

■ Features

No-wax surface layer makes daily maintenance easier.

A design layer consists of a variety of color variations and designs.

It has a flexible shock absorbing surface that reduces the impact shock and leg fatigue.

Easy to fit and install to the installation location.

Protective surface has excellent chemical resistance such as acid and alkaline.

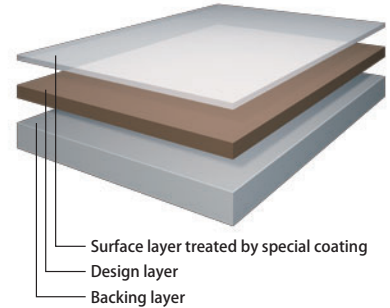

■ Specification

General name	Antivairal Vinyl floor sheet FS (JIS A 5705)
Dimensions	2.0mm (thickness) × 1,820mm (width) × 9m (length)
Number of colors	12 colors
Packaging	9m/roll
Weight	3.1kg/m ² , 51kg/roll

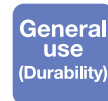

■ Color variations

12colors

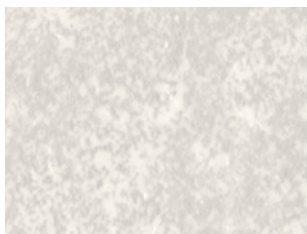

SIC-4001



SIC-4002



SIC-4004



SIC-4005



SIC-4008



SIC-4013



SIC-4014

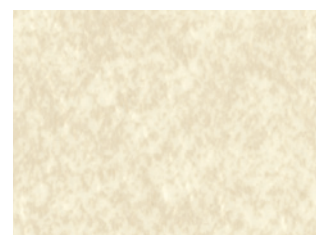

SIC-4016



SIC-4017



SIC-4019



SIC-4040

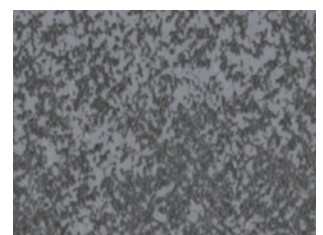

SIC-4045

LONLEUM WOODY CT ANTIVIRAL



Antiviral vinyl sheet that features detailed graining that is elegantly weaves warm flow pattern.

■ Features

No-wax surface layer makes daily maintenance easier.

A design layer consists of a variety of color variations and designs.

It has a flexible shock absorbing surface that reduces the impact shock and leg fatigue.

Easy to fit and install to the installation location.

Protective surface has excellent chemical resistance such as acid and alkaline.

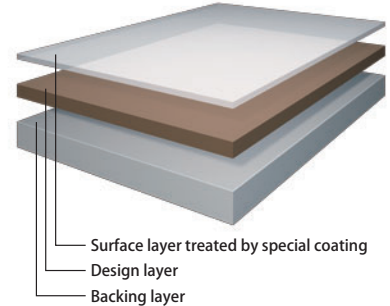

■ Specification

General name	Antiviral Vinyl floor sheet FS (JIS A 5705)
Dimensions	2.0mm (thickness) × 1,820mm (width) × 9m (length)
Number of colors	6 colors
Packaging	9m/roll
Weight	3.3kg/m ² , 54kg/roll

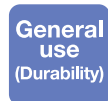

■ Color variations

6colors



WDC-6301



WDC-6302



WDC-6303

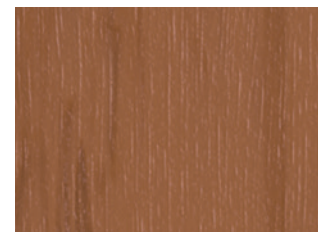

WDC-6304

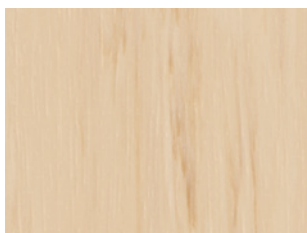

WDC-6305



WDC-6307



SANITALEUM is a high-grade UV-cured resin layered vinyl sheet flooring with a versatile design that compliments an entire facility. Added antiviral performance.

■ Features

- It has high antifouling property.
- No-wax surface layer makes daily maintenance easier.
- Heavy UV-cured resin layer prevents dirt and other fluid contamination from adhering impurity.
- It will keep flooring surface clean without additional coating.

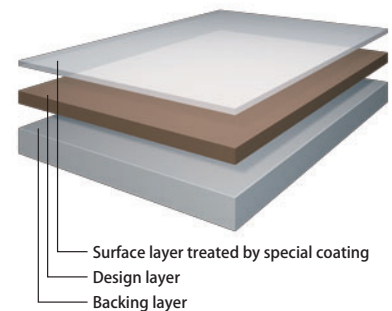

■ Specification

General name	Super antifouling/Antiviral vinyl floor sheet FS (JIS A 5705)
Dimensions	2.0mm (thickness) × 1,820mm (width) × 9m (length)
Number of colors	24 colors
Packaging	9m/roll
Weight	3.2kg/m ² , 52kg/roll



■ Color variations

24colors

Abstract Pattern



SLV-8004



SLV-8001



SLV-8011



SLV-8012



SLV-8005

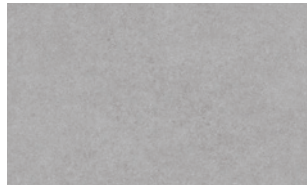

SLV-8002



SLV-8009

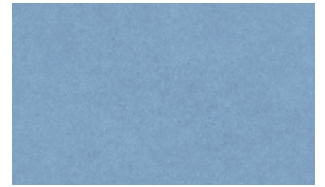

SLV-8010



SLV-8006



SLV-8003



SLV-8014



SLV-8015



SLV-8007

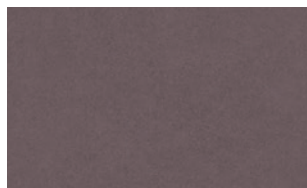

SLV-8008

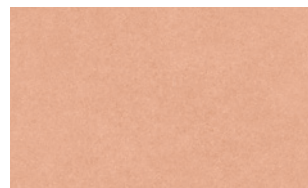

SLV-8013

Wood grain pattern



SLV-1801



SLV-1802



SLV-1836



SLV-1832

Fabric Pattern



SLV-2212

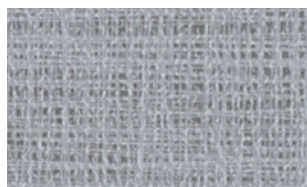

SLV-2202

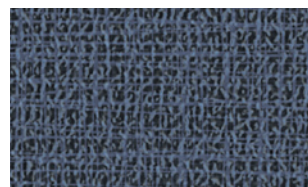

SLV-2206



SLV-2203

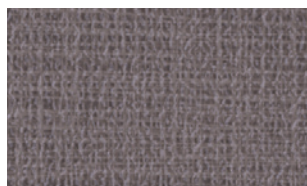

SLV-2207

LONFOAM SELENA CT ANTIVIRAL



Beautiful stone designed flooring that is engineered for safety. LONFOAM SELENA CT is a no-wax sheet vinyl flooring that has an anti-fatigue surface and cushioned layer that contributes to safety and provides comfort for leg fatigue.

■ Features

- Cushion layer for shock absorbing reduces the impact shock and leg fatigue.
- Cushion layer is also highly effective for retaining heat. No-wax surface layer makes daily maintenance easier.
- It does not require additional application of wax.
- Protective surface has excellent chemical resistance such as acid and alkaline.
- Easy to fit and install to the installation location. LONFOAM SELENA CT requires easy and little maintenance.
- Moisture, stain and slip resistant material. Anti-fungal material.

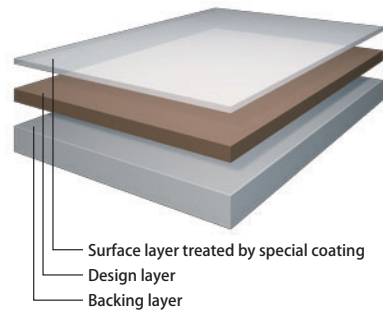

■ Specification

General name	Multi-layered vinyl floor sheet HS with antibacterial foam layer HS (JIS A 5705)
Dimensions	2.8mm (thickness) × 1,820mm (width) × 9m (length)
Number of colors	13 colors
Packaging	9m/roll
Weight	2.6kg/m ² , 43kg/roll



■ Color variations

13colors

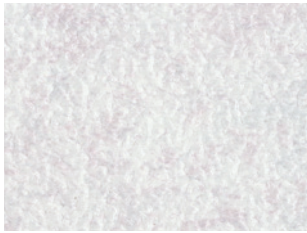

FSC-201

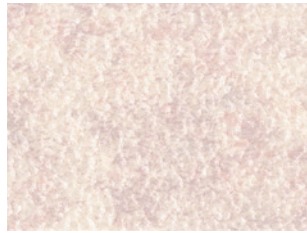

FSC-204



FSC-205

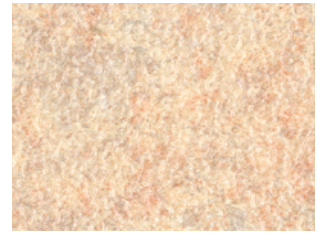

FSC-206

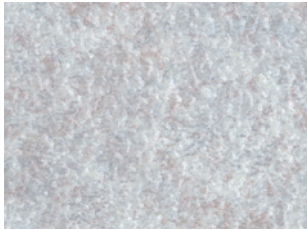

FSC-202



FSC-208

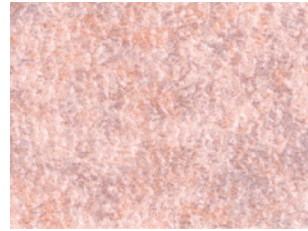

FSC-211

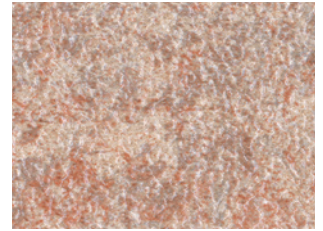

FSC-218

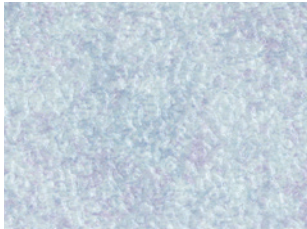

FSC-203

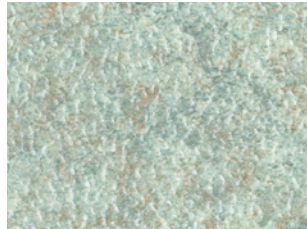

FSC-214



FSC-219

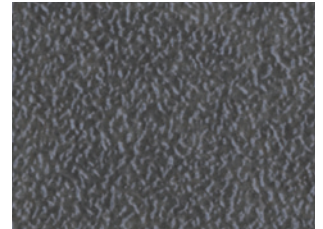

FSC-220

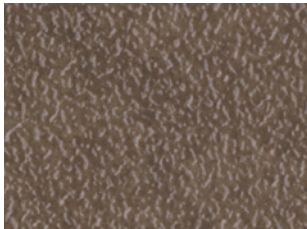

FSC-221

LONFOAM MOKU CT ANTIVIRAL



LONFORM MOKU CT delivers comfort, style and flexibility. A classic wood design that offers a cushioned layer that contributes to safety and provides comfort for leg fatigue.

■ Features

- No-wax surface layer makes daily maintenance easier.
- It has a flexible shock absorbing surface that reduces the impact shock and leg fatigue.
- Easy to fit and install to the installation location.
- LONFOAM MOKU CT requires easy and little maintenance.
- Anti-fungal material.

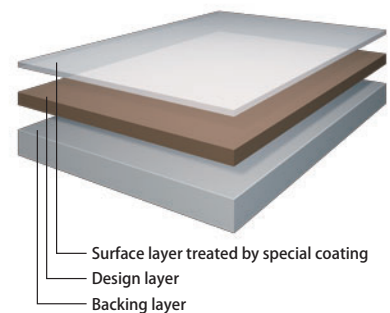

■ Specification

General name	Multi-layered vinyl floor sheet HS with antibacterial foam layer HS (JIS A 5705)
Dimensions	2.8mm (thickness) × 1,820mm (width) × 9m (length)
Number of colors	14 colors
Packaging	9m/roll
Weight	2.9kg/m ² , 48kg/roll



■ Color variations

14colors

Oak



FKC-1801



FKC-1802



FKC-1805



FKC-1806

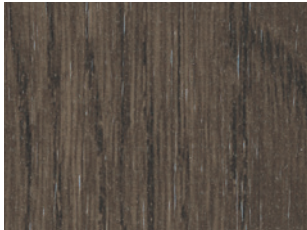

FKC-1808

Walnut

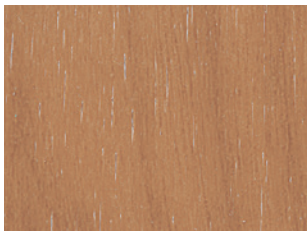

FKC-1833

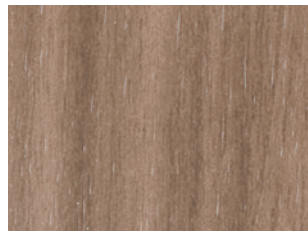

FKC-1832



FKC-1831



FKC-1838



FKC-1837



FKC-1836

Cherry



FKC-1851



FKC-1852

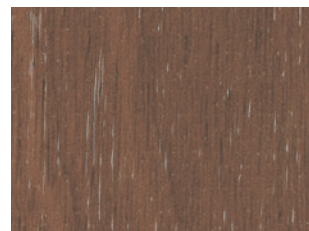

FKC-1854

LONSAFE SHEET

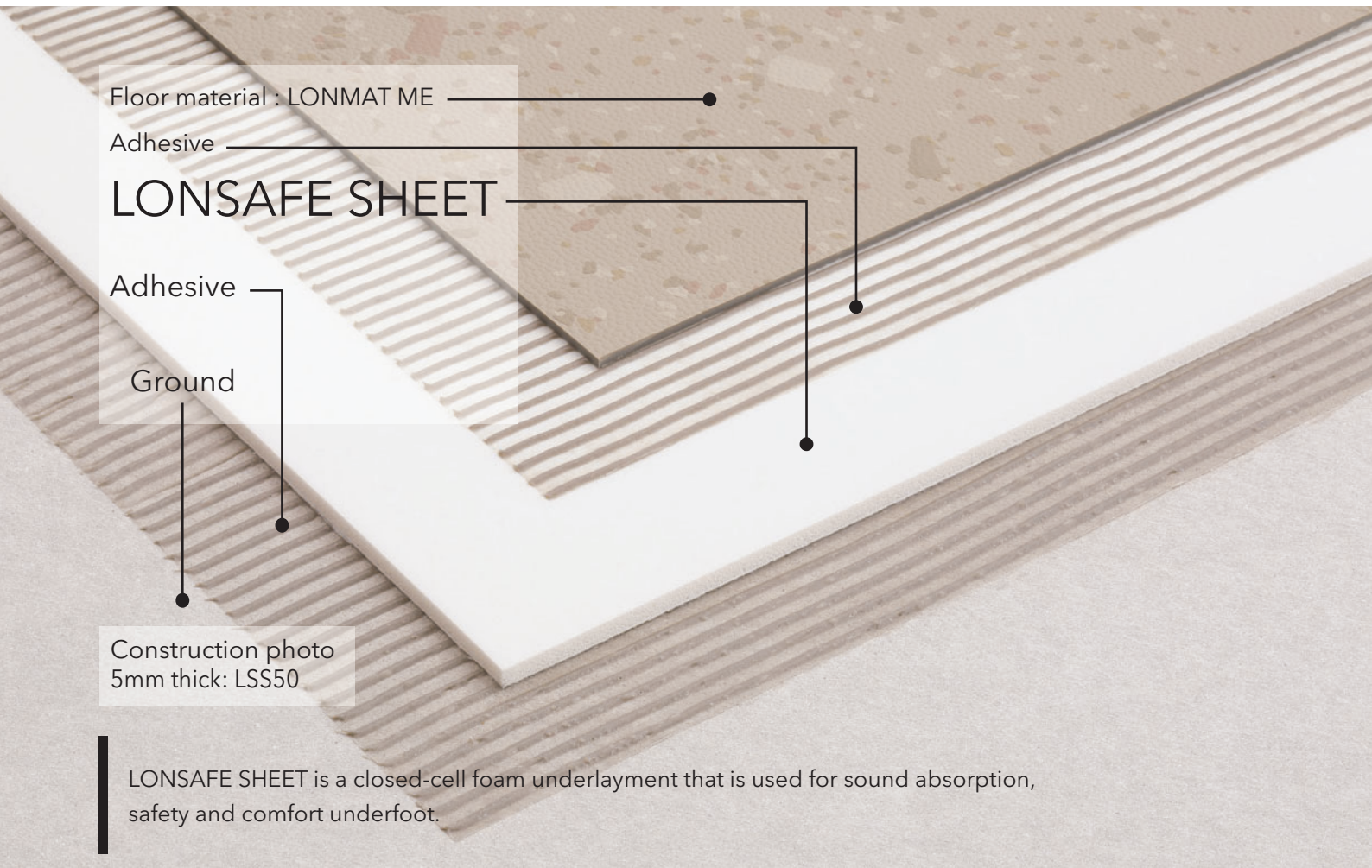

■ Features

- Shock absorbing function reduces the impact shock and leg fatigue.
- It applies to all Lonseal flooring product's underlayment and provides soft footing and quite underfoot qualities.
- Cushion layer is also highly effective in retaining heat.
- Resilient foam sheet with "bounce back ability" ensures appearance and restorability.
- It is ideal for use in fitness, gyms and hot yoga applications.
- Anti-fungal material.

■ Specification

General name	Expanded vinyl Underlay sheet
Dimensions	3.0mm (thickness) × 1,800mm (width) × 18m (length) 5.0mm (thickness) × 1,800mm (width) × 18m (length)
Number of colors	1 colors
Packaging	18m/roll
Weight	(3.0 mm) 1.1kg/m ² , 36kg/roll (5.0 mm) 1.6kg/m ² , 52kg/roll

■ Color variations 2types

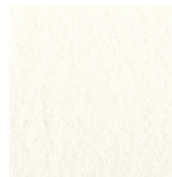

LSS30

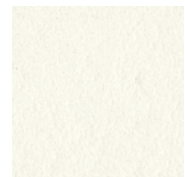

LSS50

LONLAID AS

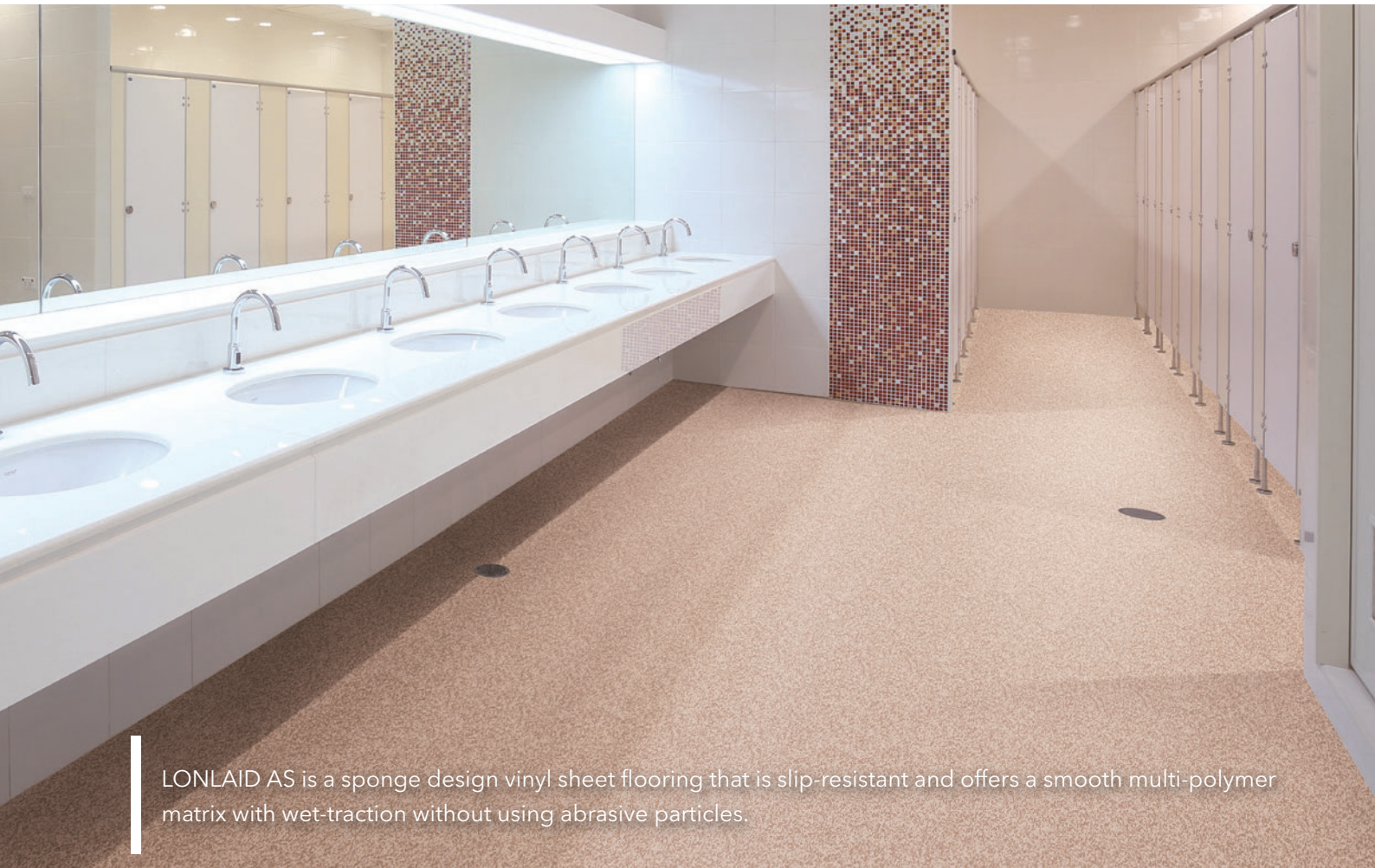

LONLAID AS is a sponge design vinyl sheet flooring that is slip-resistant and offers a smooth multi-polymer matrix with wet-traction without using abrasive particles.

■ Features

- Its surface is designed as soft, acoustic and harmless.
- Thickness of the surface layer is enough for high-foot traffic areas.
- Dedicated welding rod provide strong durability in joining sections.
- Its exert a high slip-resistance performance under the wet condition. Surface layer is designed to prevent dirt build-up.
- It requires easy and little maintenance.

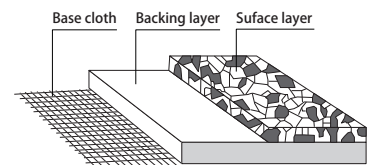

■ Specification

General name	Inlaid anti-slip vinyl floor sheet FS (JIS A 5705)
Dimensions	2.5mm (thickness) × 1,820mm (width) × 9m (length)
Number of colors	6 colors
Packaging	9m/roll
Weight	4.0kg/m ² , 66kg/roll



■ Color variations 6colors



AS-106

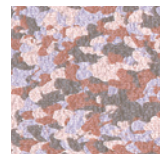

AS-107

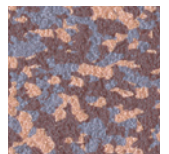

AS-103

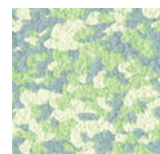

AS-108



AS-101



AS-105

LONLAID AS COMFORT



LONLAID AS COMFORT is a sponge design vinyl sheet flooring that has slip-resistant and a smooth multi-polymer matrix with wet-traction without using abrasive particles.

■ Features

- Its surface is designed as soft, acoustic and harmless.
- Thickness of the surface layer is enough for high-foot traffic areas.
- Dedicated welding rod provide strong durability in joining sections.
- It exert a high slip-resistance performance under the wet condition.
- Surface layer is designed to prevent dirt build-up.
- It requires easy and little maintenance.

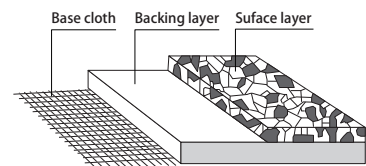

■ Specification

General name	Anti-slip vinyl floor sheet FS (JIS A 5705)
Dimensions	2.0mm (thickness) × 1,820mm (width) × 9m (length)
Number of colors	8 colors
Packaging	9m/roll
Weight	(2.0 mm) 3.1kg/m ² , 51kg/roll



■ Color variations 8colors

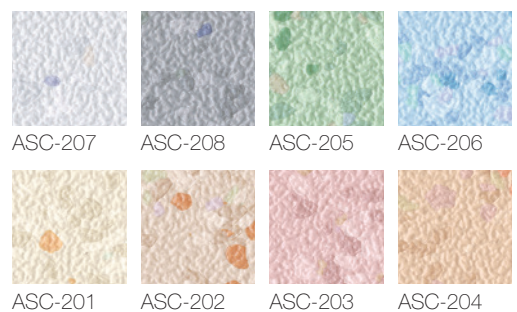

LONMAT ME DIAMOND



A steel-plate pattern design mixing industrial and beauty, LONMAT ME DIAMOND features a slip-resistant surface that prevent injuries.

■ Features

Unique embossed shape improves the safety of walking on slippery environments.
It has a flexible shock absorbing surface that reduces the impact shock and leg fatigue.

●Sectional view

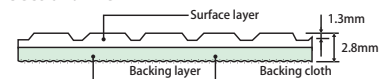

●Pattern dimensions

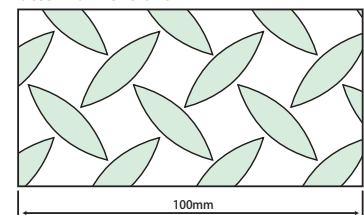

■ Specification

General name	Anti-slip vinyl floor sheet FS (JIS A 5705)
Dimensions	2.8mm (thickness of convex part) × 1,820mm (width) × 9m (length)
Number of colors	3 colors
Packaging	9m/roll
Weight	2.7kg/m ² , 44kg/roll

■ Color variations 3colors

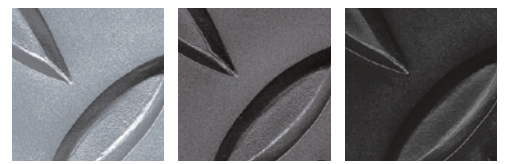

DM-161

DM-164

DM-135

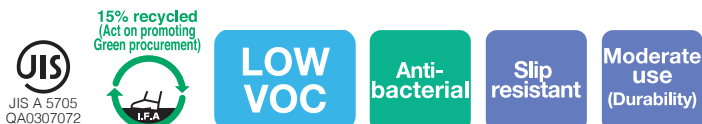

LONMAT ME HOLZWOOD



Wood grain pattern slip-resistance sheet vinyl flooring that is suitable for open corridors and semi-exterior areas in commercial spaces.

■ Features

It has excellent weather resistance with little color deterioration and color change due to the scorching sun light.

It has excellent slip resistance performance by surface embossed pattern.

It pursues safety of walking and designability.

It absorbs the noise of walking by the elasticity and unique embossed pattern of soft vinyl resin.

■ Specification

General name	Anti-slip vinyl floor sheet FS (JIS A 5705)
Dimensions	2.5mm (thickness of convex part) × 1,350mm (width) × 9m (length) 2.5mm (thickness of convex part) × 1,820mm (width) × 9m (length)
Number of colors	3 colors
Packaging	9m/roll
Weight	41kg/roll (1,350mm width) 55.7kg/roll (1,820mm width)



■ Color variations

3colors

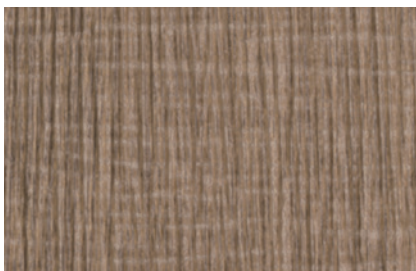

HZ-01

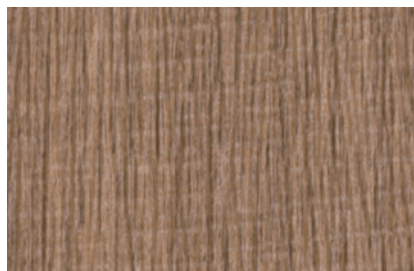

HZ-02

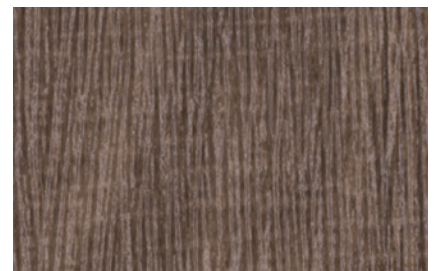

HZ-03



HZ-01

LONMAT ME PASELAT

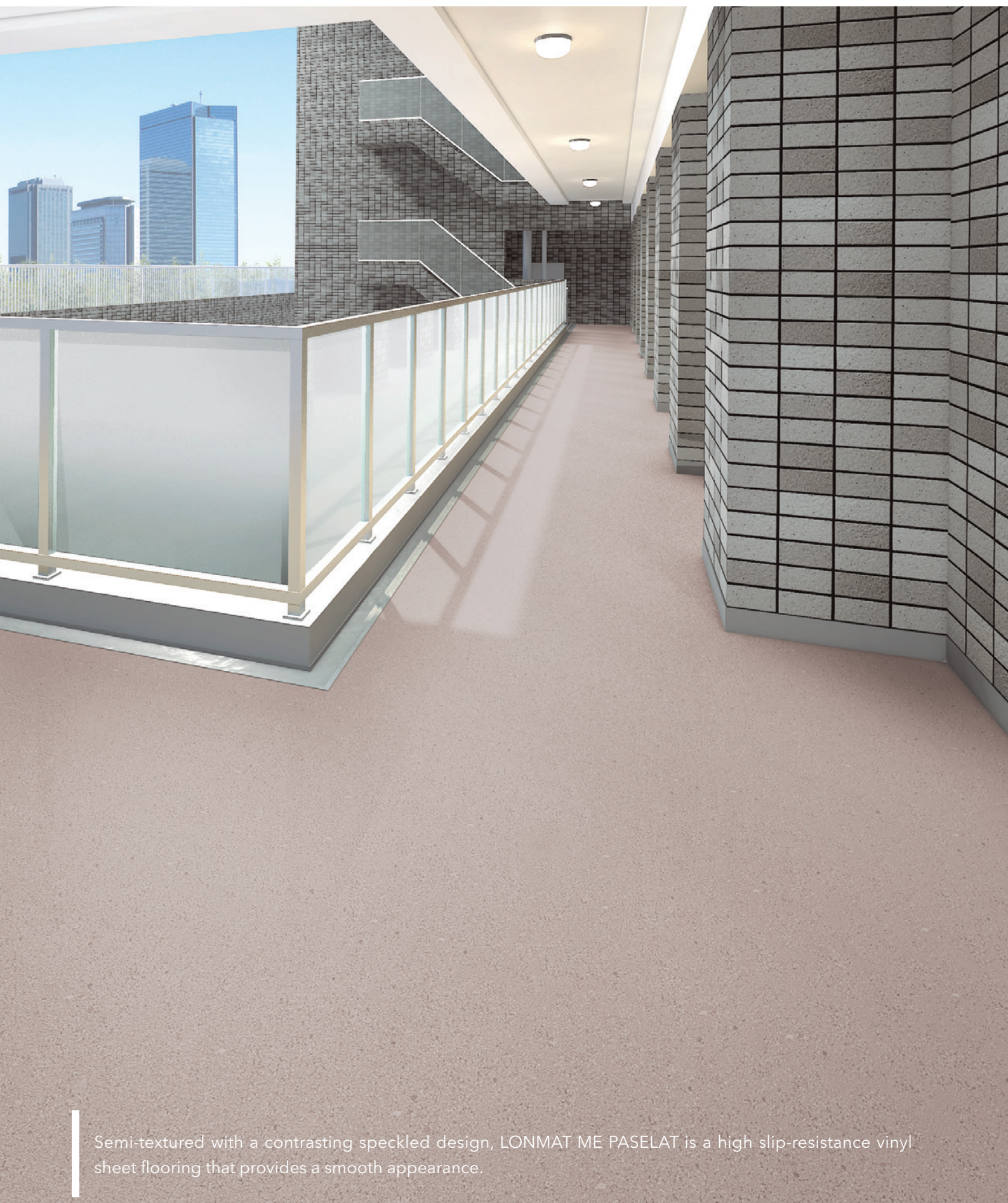

Semi-textured with a contrasting speckled design, LONMAT ME PASELAT is a high slip-resistance vinyl sheet flooring that provides a smooth appearance.

■ Features

It is designed to exert a high slip-resistance performance in multidirectional movement.

It has high tolerance to color changes due to sun light under any weather conditions.

Noise barrier properties absorbs footsteps.

It requires easy and little maintenance.

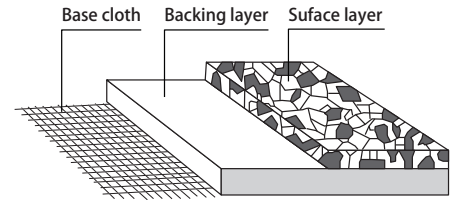

■ Specification

General name	Anti-slip vinyl floor sheet FS (JIS A 5705)
Dimensions	2.5mm (thickness of convex part) × 1,820mm (width) × 9m (length)
Number of colors	9 colors
Packaging	9m/roll
Weight	3.7kg/m ² , 61kg/roll



■ Color variations

9colors



AT-410



AT-407

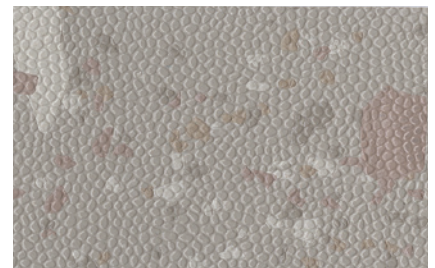

AT-401



AT-409

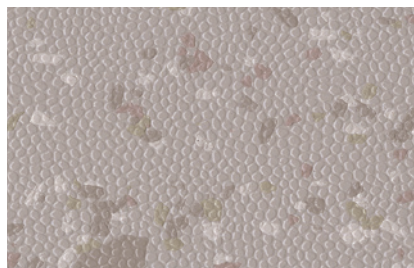

AT-411

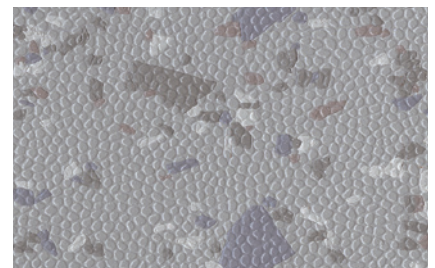

AT-412



AT-402

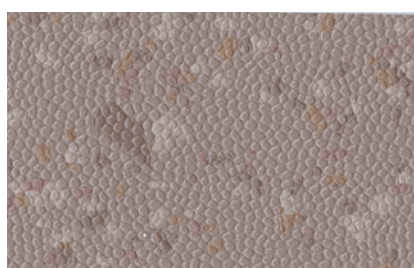

AT-403

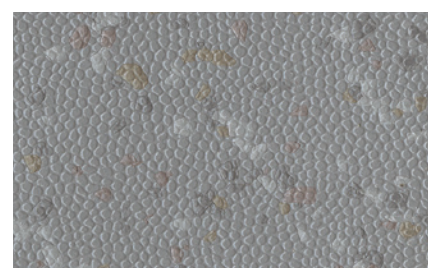

AT-404

LONMAT ME ROZETA



Slip-resistance vinyl sheet flooring that is suitable for open corridors and semi-exterior areas in commercial spaces.

■ Features

It is designed to exert a high slip-resistance performance in multidirectional movement.

It has high tolerance to color changes due to sun light under any weather conditions.

Noise barrier properties absorbs footsteps.

It requires easy and little maintenance.

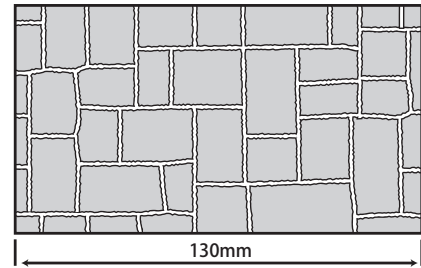

■ Specification

General name	Anti-slip vinyl floor sheet FS (JIS A 5705)
Dimensions	2.5mm (thickness of convex part) × 1,820mm (width) × 9m (length)
Number of colors	4 colors
Packaging	9m/roll
Weight	3.1kg/m ² , 51kg/roll



■ Color variations

4colors



RT-31



RT-30



RT-21



RT-32

LONMAT ME SCORE



Resilient slip-resistance vinyl sheet flooring that can withstand high-traffic areas and inhospitable environments.

■ Features

It is designed to exert a high slip-resistance performance in multidirectional movement.

It has high tolerance to color changes due to sun light under any weather conditions.

Noise barrier properties absorbs footsteps.

It requires easy and little maintenance.

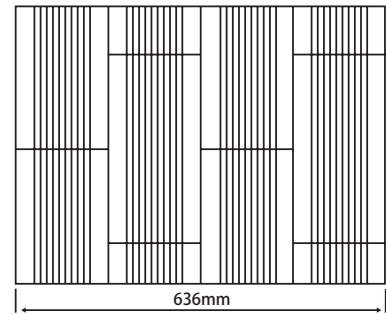
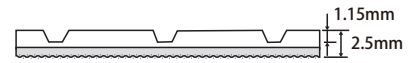

■ Specification

General name	Anti-slip vinyl floor sheet FS (JIS A 5705)
Dimensions	2.5mm (thickness of convex part) × 1,820mm (width) × 9m (length)
Number of colors	5 colors
Packaging	9m/roll
Weight	3.1kg/m ² , 51kg/roll

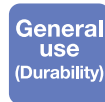

■ Color variations

5colors



SCE-202



SCE-203



SCE-201



SCE-204



SCE-205

LONMAT ME TWILL II

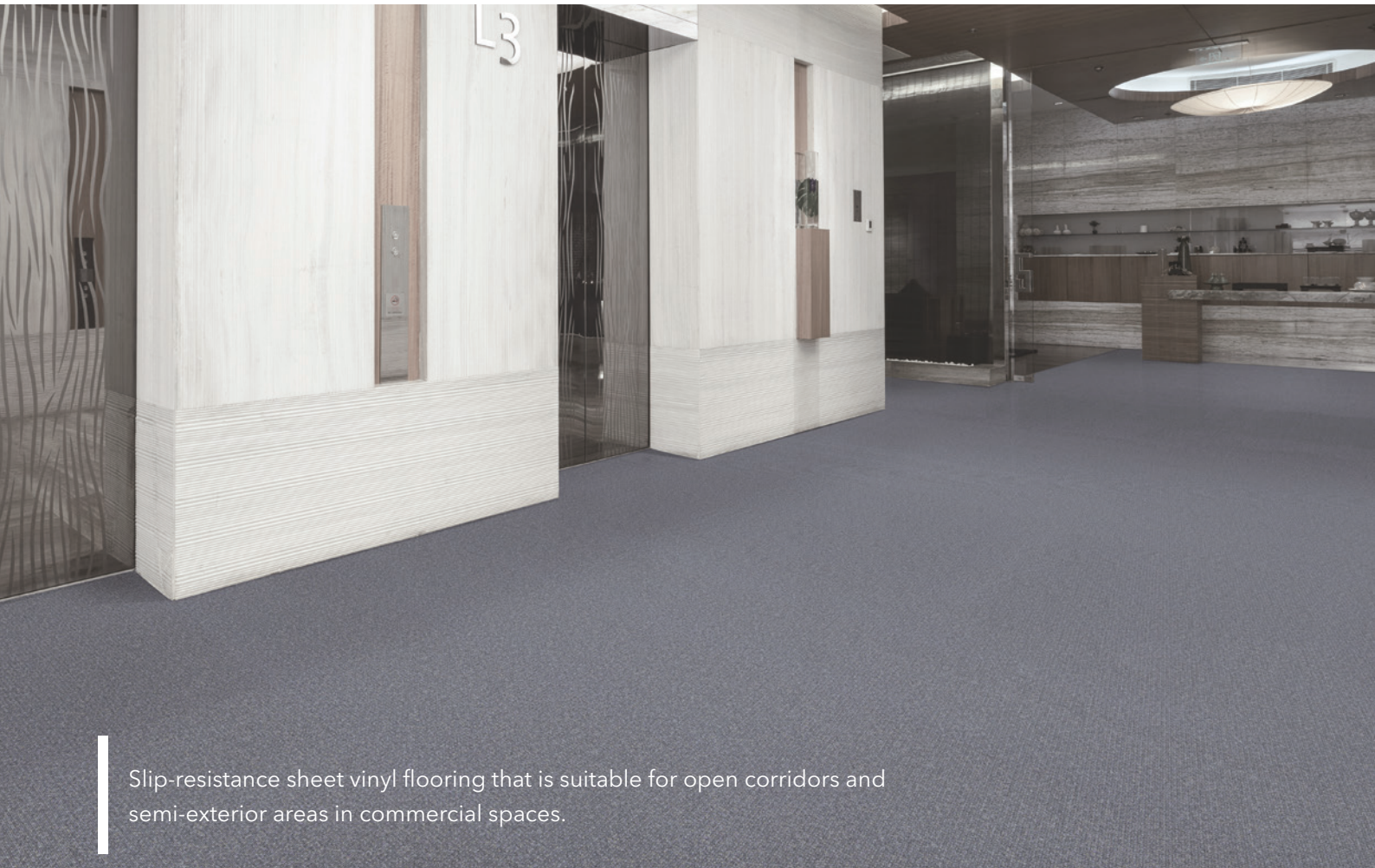

Slip-resistance sheet vinyl flooring that is suitable for open corridors and semi-exterior areas in commercial spaces.

■ Features

Its surface is designed as soft, acoustic and harmless.

Thickness of the surface layer is enough for high-foot traffic areas.

Dedicated welding rod provide strong durability in joining sections.

It exert a high slip-resistance performance under the wet condition. Surface layer is designed to prevent dirt build-up.

It requires easy and little maintenance.

■ Specification

General name	Anti-slip Vinyl floor sheet FS (JIS A 5705) for apartment's open corridors
Dimensions	2.5mm (thickness of convex part) × 1,350mm (width) × 9m (length) 2.5mm (thickness of convex part) × 1,820mm (width) × 9m (length)
Number of colors	5 colors
Packaging	9m/roll
Weight	3.3kg/m ²
	40kg/roll (1,350mm width)
	54kg/roll (1,820mm width)



■ Color variations 5 colors



TWL-401



TWL-402

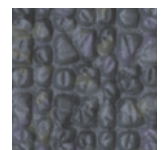

TWL-403



TWL-404



TWL-405

LONMAT ME JASPER



Anti-slip vinyl floor sheet suitable for shared space, open corridors of housing complex, etc.

■ Features

It has excellent weather resistance with little color deterioration and color change due to the scorching sun light.

It has excellent slip resistance performance by surface embossed pattern.

It pursues safety of walking and designability.

It absorbs the noise of walking by the elasticity and unique embossed pattern of soft vinyl resin.

●Cross-section

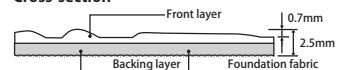

●Pattern dimensions

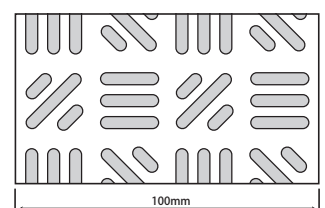

■ Specification

General name	Anti-slip Vinyl floor sheet FS (JIS A 5705) for apartment's open corridors
Dimensions	2.5mm (thickness of convex part) × 1,350mm (width) × 9m (length) 2.5mm (thickness of convex part) × 1,820mm (width) × 9m (length)
Number of colors	7 colors
Packaging	9m/roll
Weight	36kg/roll (1,350mm width) 49kg/roll (1,820mm width)

■ Color variations 7colors



JP-11 JP-12 JP-13



JP-15 JP-27 JP-28



JP-220



LONMAT ME RESTARIA HS

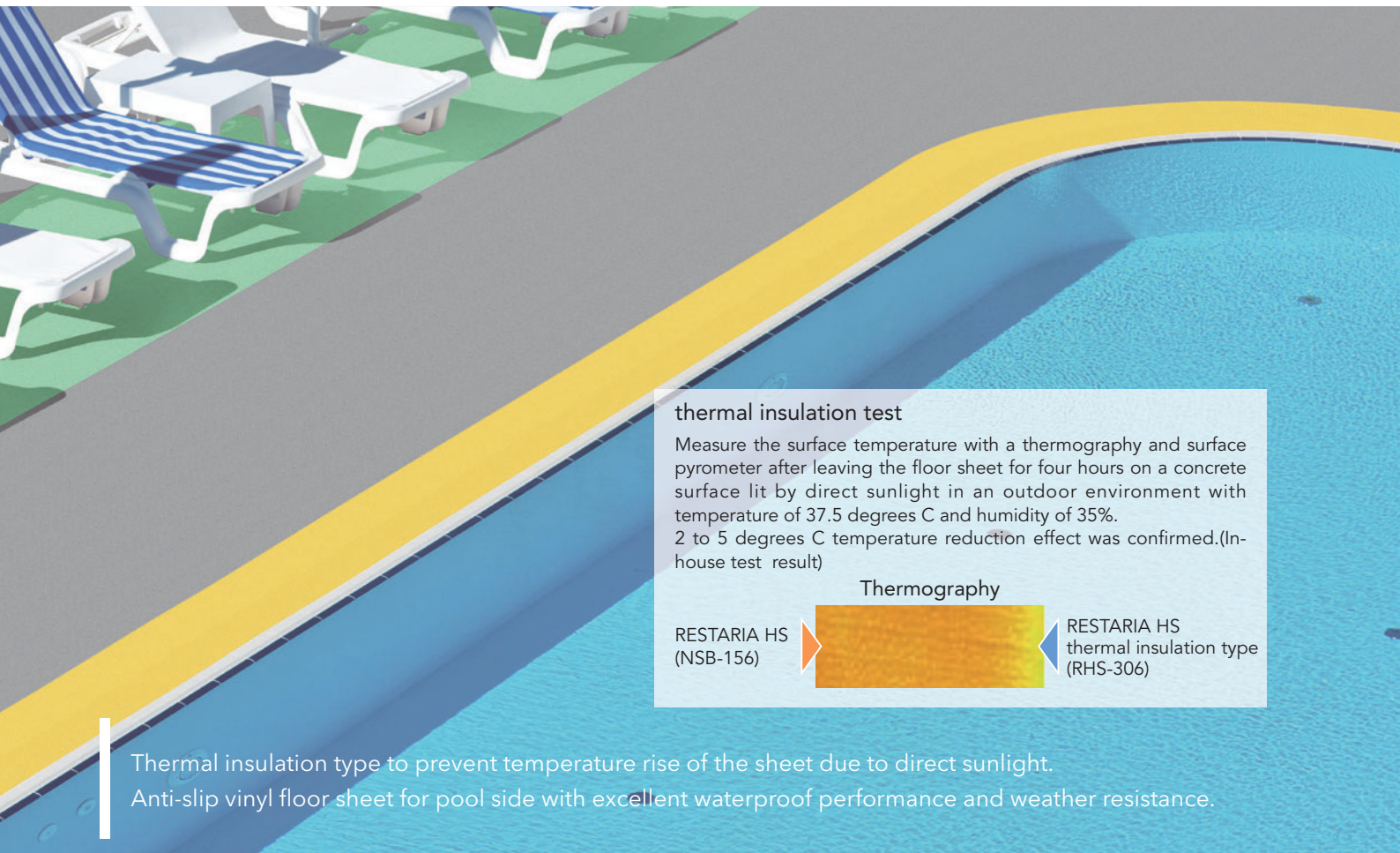

thermal insulation test
 Measure the surface temperature with a thermography and surface pyrometer after leaving the floor sheet for four hours on a concrete surface lit by direct sunlight in an outdoor environment with temperature of 37.5 degrees C and humidity of 35%. 2 to 5 degrees C temperature reduction effect was confirmed.(In-house test result)

Thermography

RESTARIA HS (NSB-156)  RESTARIA HS thermal insulation type (RHS-306)

Thermal insulation type to prevent temperature rise of the sheet due to direct sunlight.
 Anti-slip vinyl floor sheet for pool side with excellent waterproof performance and weather resistance.

■ Features

- RESTARIA HS prevents temperature rise of the sheet due to direct sunlight.
- It has multidirectional pattern with excellent slip resistance.
- It is suitable for use in rooftops of apartments and for porches, balconies, and connecting corridors without a roof.
- Strong and excellent chemical resistance properties against damages by swimming pool disinfectants.
- It improves the waterproof performance of Urethane-coated .
- Weatherproof test was conducted at the poolside.

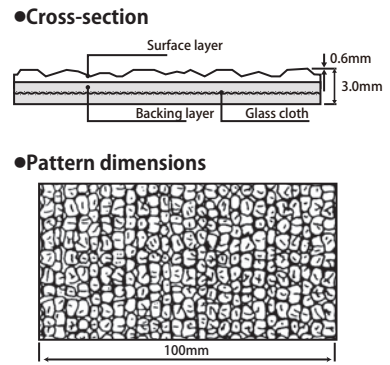

■ Specification

General name	Anti-slip vinyl floor sheet for poolside FS (JIS A 5705)
Dimensions	3.0mm (thickness of convex part) × 1,820mm (width) × 9m (length)
Number of colors	5 colors
Packaging	9m/roll
Weight	4.1kg/m ² , 67kg/roll









■ Color variations 5colors



LONMAT ME RESTARIA SB

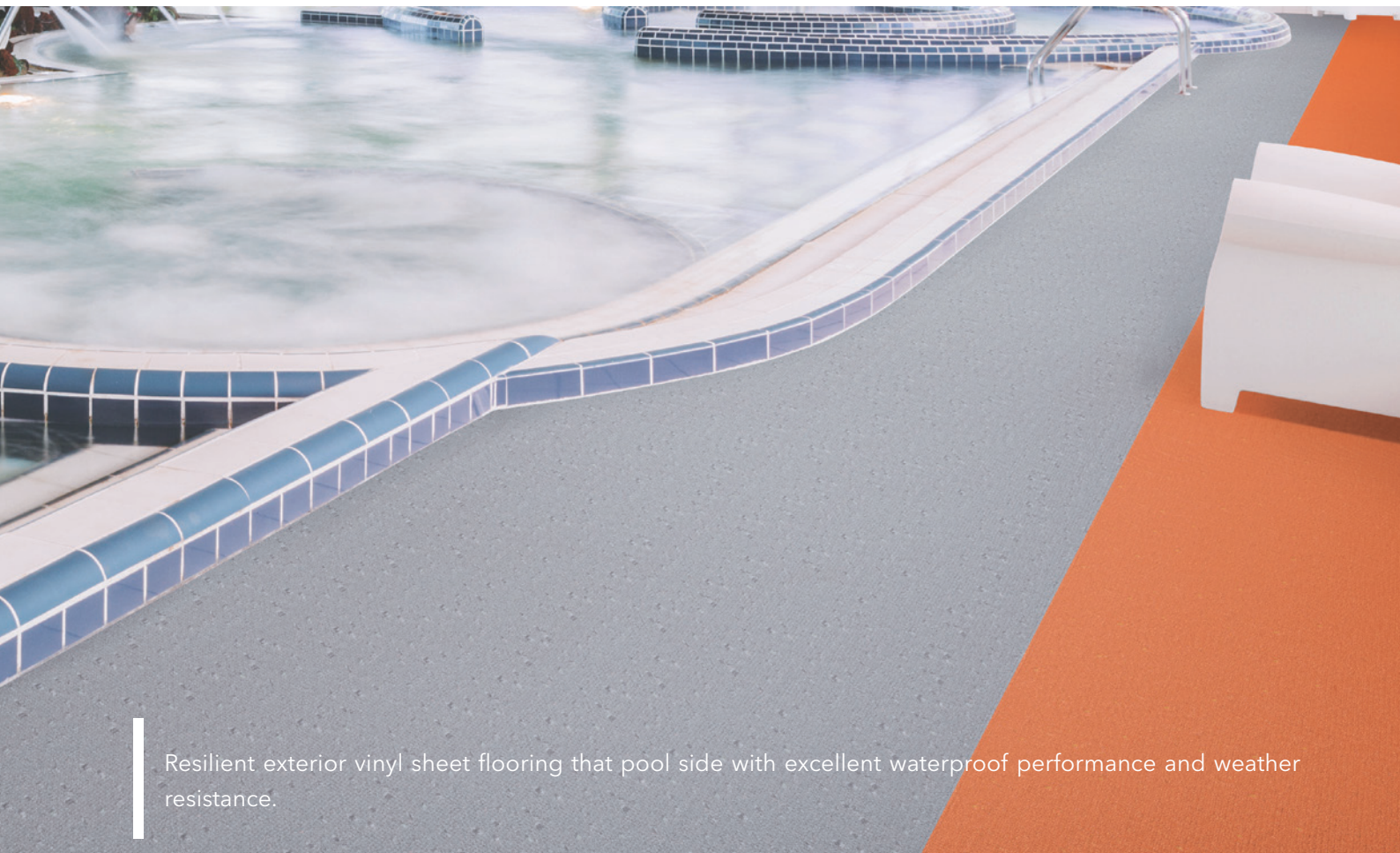

Resilient exterior vinyl sheet flooring that pool side with excellent waterproof performance and weather resistance.

■ Features

It has multidirectional pattern with excellent slip resistance.

It is suitable for use in rooftops of apartments and for porches, balconies, and connecting corridors without a roof.

Strong and excellent chemical resistance properties against damages by swimming pool disinfectants.

It improves the waterproof performance of Urethane-coated .

Weatherproof test was conducted at the poolside.

● Cross-section

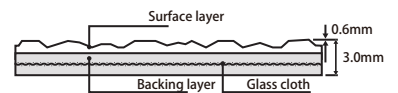

● Pattern dimensions

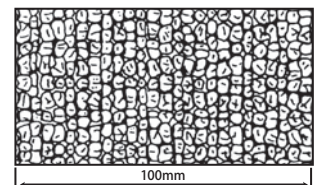

■ Specification

General name	Anti-slip vinyl floor sheet for poolside FS (JIS A 5705)
Dimensions	3.0mm (thickness of convex part) × 1,820mm (width) × 9m (length)
Number of colors	9 colors
Packaging	9m/roll
Weight	4.2kg/m ² , 69kg/roll

■ Color variations 9colors

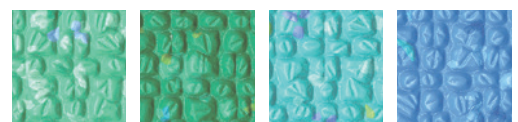

NSB-151 NSB-152 NSB-153 NSB-154

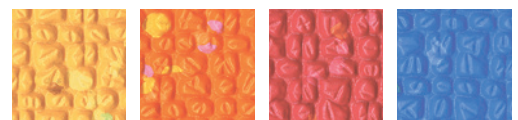

NSB-157 NSB-158 NSB-159 NSB-155



NSB-156



LONSTEP ME FZK EMBOSS TYPE



Improves the visibility by the nosing line. Universal design prioritizing safety.
The nosing, caution line, tread sheet, and riser sheet are integrated.
For more stylish walking space creation.

■ Features

It realizes high visibility by adopting different colors for the tread sheet, nosing and the line of the nosing.
High slip resistance is realized by the unique emboss design.
Excellent weather and abrasion resistance to endure in use under severe conditions.
The soft vinyl resin material and unique emboss shape prevent footsteps.

■ Specification

General name	Anti-slip vinyl floor material for stairs
Dimensions	2.4mm (thickness of nosing convex) × 915mm (width) × 580mm (depth) 2.4mm (thickness of nosing convex) × 1,215mm (width) × 580mm (depth)
Number of colors	Nosing 2 colors Tread sheet 7 colors
Nosing R	4R
Packaging	7 sheets/case
Weight	915mm (width) type: 2.0kg/sheet, 14.0kg/case (7 sheets) 1,215mm (width) type: 2.6kg/sheet, 18.2kg/case (7 sheets)

15% recycled
(Act on promoting
Green procurement)



Slip
resistant

Outdoor
use

Weather
resistant

General
use
(Durability)

■ Color variations 7colors

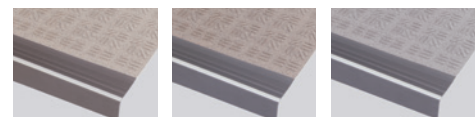

FZK-11

FZK-12

FZK-13

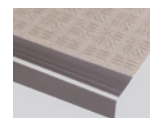

FZK-15

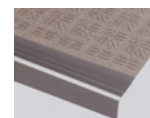

FZK-27

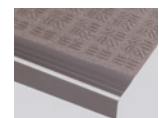

FZK-28

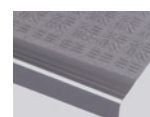

FZK-220

LONSTEP ME FZK FLAT TYPE

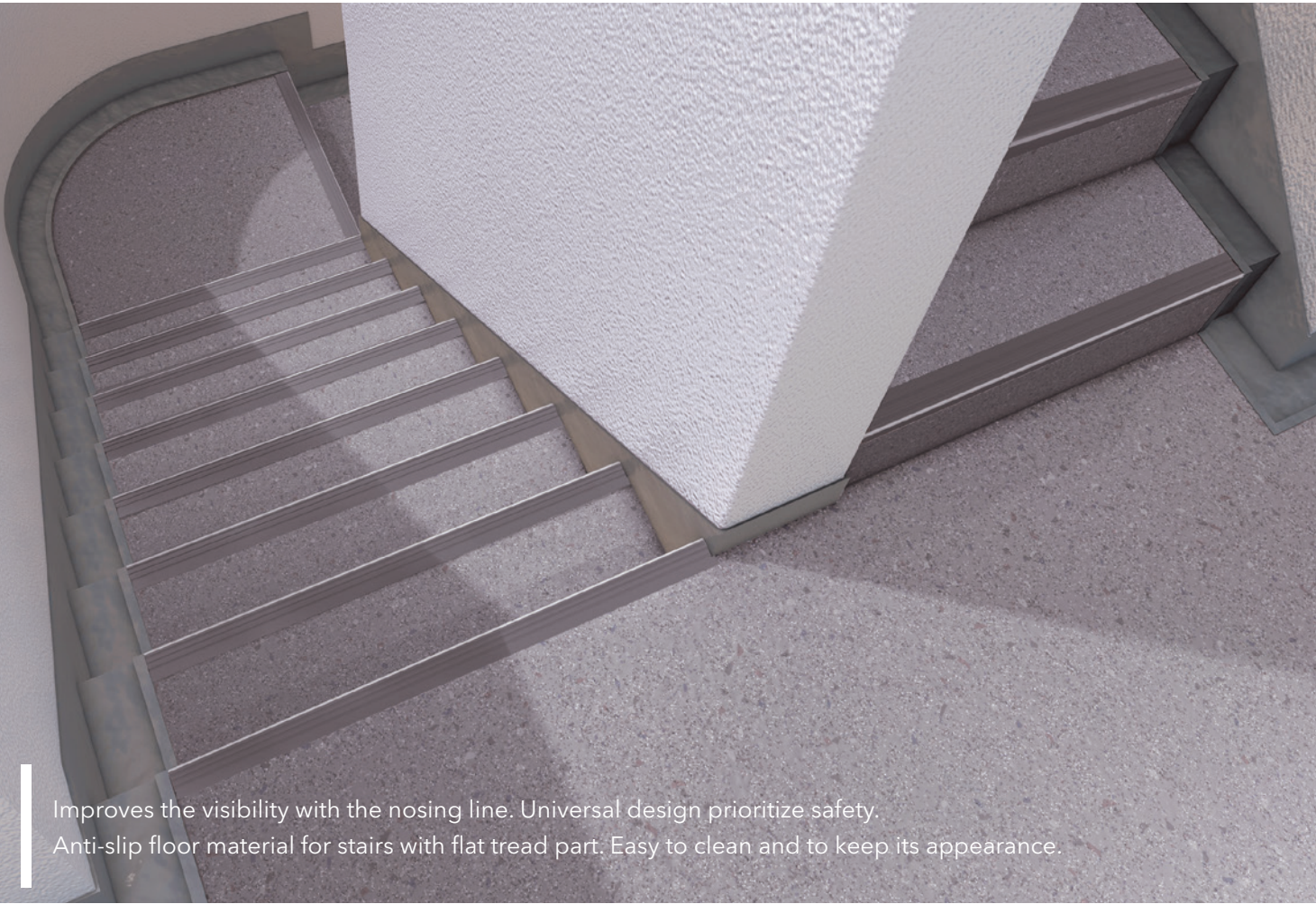

Improves the visibility with the nosing line. Universal design prioritize safety.
Anti-slip floor material for stairs with flat tread part. Easy to clean and to keep its appearance.

■ Features

It realizes high visibility by adopting different colors for the tread sheet, nosing and the line of the nosing.

It is smooth and has high slip resistance. It is easy to clean because of the flat tread part.

It is excellent weather and abrasion resistance to endure in use under severe conditions.

■ Specification

General name	Anti-slip vinyl floor material for stairs
Dimensions	2.4mm (thickness of nosing convex) × 915mm (width) × 480mm (depth) 2.4mm (thickness of nosing convex) × 1,215mm (width) × 480mm (depth)
Number of colors	Nosing 2 colors Tread sheet 6 colors
Nosing R	4R
Packaging	7 sheets/case
Weight	915mm (width) type: 1.6kg/sheet, 11.2kg/case (7 sheets) 1,215mm (width) type: 2.1kg/sheet, 14.7kg/case (7 sheets)

15% recycled
(Act on promoting
Green procurement)



Slip resistant

Outdoor use

Weather resistant

General use
(Durability)

●Cross-section

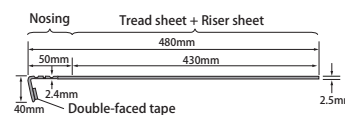

●Nosing

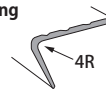

●Development view

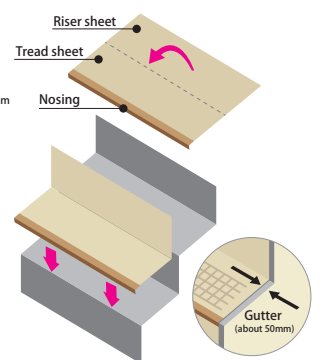

■ Color variations 6colors

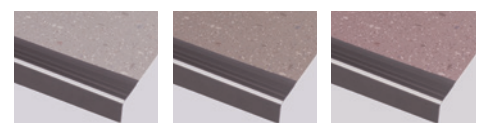

FZK-401

FZK-402

FZK-403

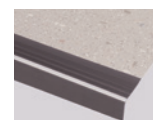

FZK-407

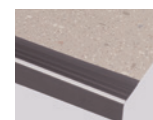

FZK-410

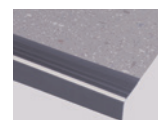

FZK-412

LONSTAC R



A functional vinyl sheet flooring, LONSTAC R prevents the build-up of static electricity and hinders adhesion of dust by an exceptional anti-static feature.

■ Features

It is formulated for absorbing static electricity. Absorbing static electricity effect is long-continued.

It can be integrated with dedicated welding rod. It prevents dust build-up.

It requires easy and little maintenance.

Easy to fit and install to the installation location.

Protective surface has excellent chemical resistance such as acid and alkaline.

It comply with NFPA electrical compliant.

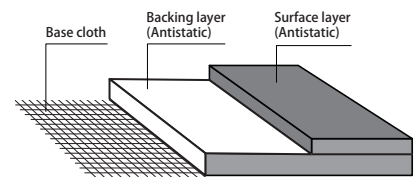

■ Specification

General name	Antistatic/Antibacterial vinyl floor sheet FS (JIS A 5705)
Dimensions	2.0mm (thickness) × 1,820mm (width) × 9m (length)
Number of colors	4 colors
Packaging	9m/roll
Weight	3.2kg/m ² , 52kg/roll
Conductivity	10 ⁸ ~10 ⁹ 【Ω】

■ Color variations 4colors

Plain

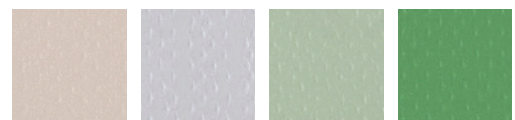

LSR-134

LSR-902

LSR-138

LSR-512

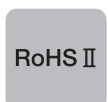

FA STAC R



A functional vinyl sheet flooring, FA STAC R prevents the build-up of static electricity and hinders adhesion of dust by an exceptional anti-static feature. In addition to have antistatic performance which is equivalent to LONSTAC R, FA STAC R has high durability to rolling loads.

■ Features

It is formulated for absorbing static electricity. Absorbing static electricity effect is long-continued. It has high durability to rolling loads.

It can be integrated with dedicated welding rod. It prevents dust build-up.

It requires easy and little maintenance.

Easy to fit and install to the installation location.

Protective surface has excellent chemical resistance such as acid and alkaline.

It comply with NFPA electrical compliant.

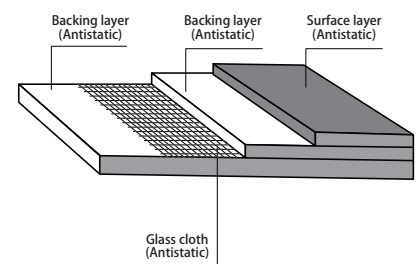

■ Specification

General name	Antistatic/Antibacterial vinyl floor sheet FS (JIS A 5705)
Dimensions	2.0mm (thickness) × 1,820mm (width) × 9m (length)
Number of colors	4 colors
Packaging	9m/roll
Weight	3.1kg/m ² , 51kg/roll
Conductivity	10 ⁸ ~10 ⁹ [Ω]

■ Color variations 4colors

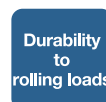
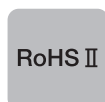

CD LEUM R



High-quality vinyl sheet flooring that features anti-static conductive materials that are suitable for areas that has houses electrical equipment.

■ Features

- It is formulated for absorbing static electricity.
- It can be integrated with dedicated welding rod.
- It prevents dust build-up.
- It requires easy and little maintenance. Easy to fit and install to the installation location.
- Protective surface has excellent chemical resistance such as acid and alkaline.
- It comply with NFPA electrical compliant.

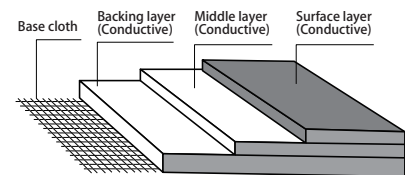

■ Specification

General name	Conductive/Antibacterial vinyl floor sheet FS (JIS A 5705)
Dimensions	2.0mm (thickness) × 1,820mm (width) × 9m (length)
Number of colors	5 colors
Packaging	9m/roll
Weight	3.1kg/m ² , 51kg/roll
Conductivity	10 ⁶ ~10 ⁷ [Ω]

■ Color variations 5colors

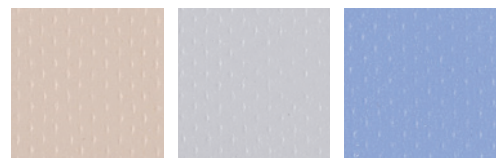

CDR-134 CDR-902 CDR-602



CDR-138 CDR-512

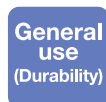
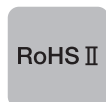

TCD R



High-quality vinyl sheet flooring that features anti-static conductive and durable to rolling loads materials that are suitable for areas that has houses electrical equipment.

■ Features

- It is formulated for absorbing static electricity.
- It has high durability to rolling loads.
- It can be integrated with dedicated welding rod.
- CD LEUM R prevents dust build-up.
- It requires easy and little maintenance. Easy to fit and install to the installation location.
- Protective surface has excellent chemical resistance such as acid and alkaline.
- It comply with NFPA electrical compliant.

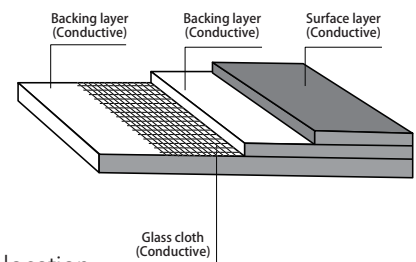

■ Specification

General name	Conductive/Antibacterial vinyl floor sheet FS (JIS A 5705)
Dimensions	2.0mm (thickness) × 1,820mm (width) × 9m (length)
Number of colors	5 colors
Packaging	9m/roll
Weight	3.1kg/m ² , 50kg/roll
Conductivity	10 ⁶ ~10 ⁷ [Ω]

■ Color variations 5colors

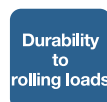
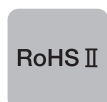

ANTI CHEMICAL SUPERLEUM



A laboratory-grade sheet flooring that is engineered to resist strong chemicals, acid and alkaline.

■ Features

- A high density, cross-linked surface layer that uses vinyl chloride resin.
- Industrial strength chemical, acid and alkaline resistance.
- It is formulated for absorbing static electricity.
- It has high heat resistance property in high temperature environments.
- It is extremely durable and performs well in high foot traffic areas with minimal wear.
- Easy to fit and install to the installation location.
- It requires easy and little maintenance. Moisture and stain resistant material.
- It can be integrated with dedicated welding rod or epoxy joint sealer.
- Anti-fungal material. It comply with NFPA electrical compliant.

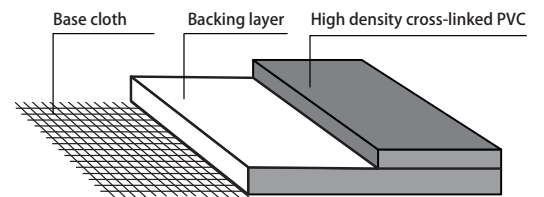

■ Specification

General name	Chemical resistant/Antistatic/Antibacterial vinyl floor sheet FS (JIS A 5705)
Dimensions	2.0mm (thickness) × 1,820mm (width) × 9m (length)
Number of colors	7 colors
Packaging	9m/roll
Weight	2.9kg/m ² , 48kg/roll



■ Color variations

7colors



TS-3

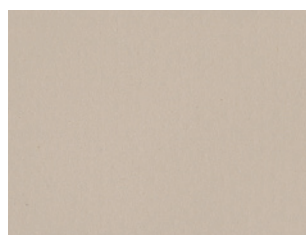

TS-1



TS-5



TS-6



TS-7



TS-4

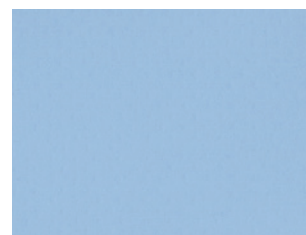

TS-9

LONTILE OA MERAVYWOOD CT



Warm oak and rough-cut old wood pattern create a sophisticated Japanese modern space.
A wax-free, antistatic vinyl floor tile that decorates the office space with high quality.

■ Features

Formulated to absorb static electricity.

Protects OA equipment and personal computers from electrostatic damage.

No-wax surface layer makes daily maintenance easier.

It does not require additional application of wax.

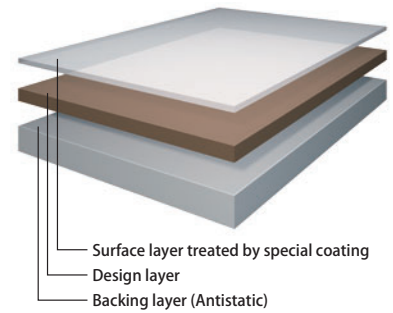

■ Specification

General name	Antifouling/Antistatic Loose Lay Vinyl floor tile FOA (JIS A 5705)
Dimensions	5.0mm (thickness) × 166.7mm (width) × 1,000mm (length)
Number of colors	7 colors
Packaging	12 pcs/case
Weight	8.9kg/m ² , 17.8kg/case



■ Color variations

7colors

Oak

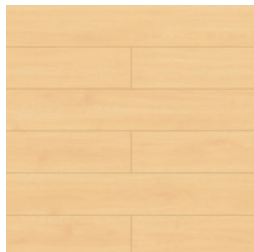

OAC-811

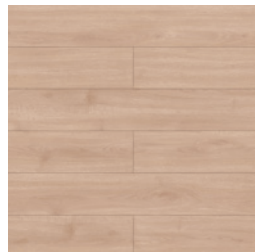

OAC-812

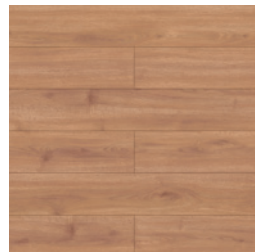

OAC-813



OAC-814



Antique Oak



OAC-821



OAC-822



OAC-823

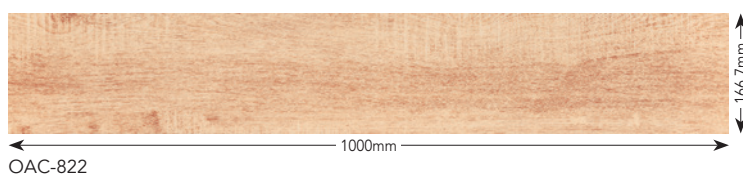

LONTILE OA IDEASTONE CT



A lineup of comfortable appearances (textures) with a slate pattern.
A wax-free, antistatic vinyl floor tile that looks great in an industrial space such as an office.

■ Features

Formulated to absorb static electricity.

Protects OA equipment and personal computers from electrostatic damage.

No-wax surface layer makes daily maintenance easier.

It does not require additional application of wax.

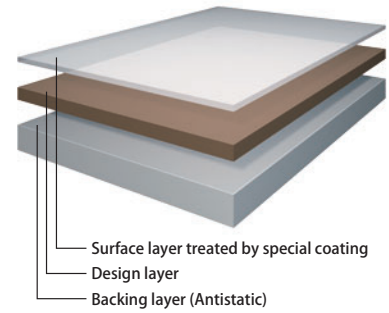

■ Specification

General name	Antifouling/Antistatic Loose Lay Vinyl floor tile FOA (JIS A 5705)
Dimensions	5.0mm (thickness) × 500mm (width) × 500mm (length)
Number of colors	3 colors
Packaging	10 pcs/case
Weight	8.4kg/m ² , 21.0kg/case



■ Color variations

3colors



OAC-911

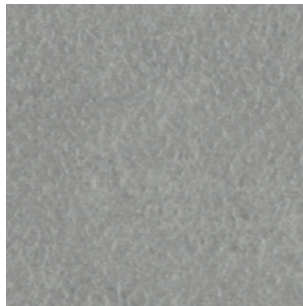

OAC-912

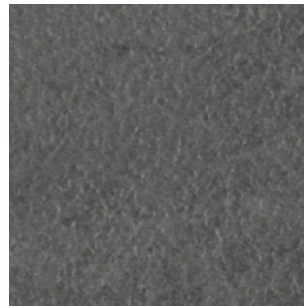

OAC-913



OAC-911

LONWALL GUARD L ANTIVIRAL



LONWALL GUARD L is designed for use in high-traffic areas that are subjected to abuse from impact, gouges and scratches. It extends the life cycle of walls and reduces maintenance costs of labor and repair.

■ Features

- It has Anti-bacterial, anti-viral and anti-fungal properties.
- It is extremely durable and performs well in high-traffic areas with minimal wear.
- Easy to fit and install to the installation location.
- It requires easy and little maintenance.
- It has a flexible shock absorbing surface that reduces the impact shock.
- Scratch resistant material.

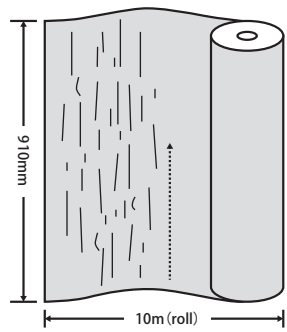

■ Specification

General name	Antiviral/Antifungal vinyl sheet for spandrel walls
Dimensions	0.9mm (thickness) × 910mm (width) × 10m (length)
Number of colors	11 colors
Packaging	10m/roll
Weight	1.0kg/m ² , 9.1kg/roll

LOW VOC

Antiviral

Anti-bacterial

Antifungal

Color variations

11colors



GI-251



GI-252

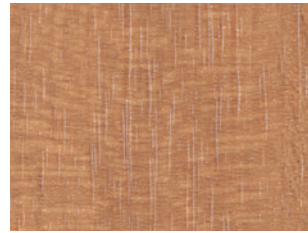

GI-253



GI-351



GI-352



GI-353



GI-354



GL-451



GL-452

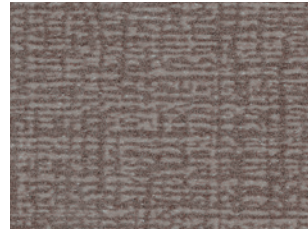

GL-453



GL-551

Antiviral activity

In general terms, when a virus is inactivated, it disrupts its original growth cycle.

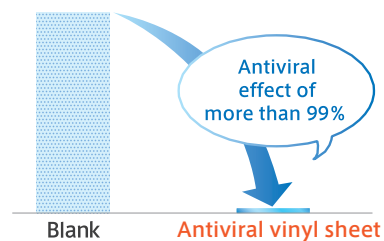
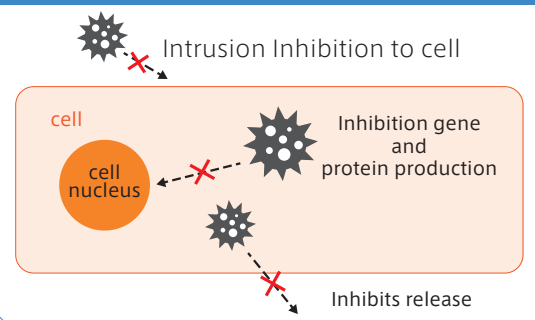

It has the performance that is very higher than a normal vinyl sheet

LONWALL GUARD SP



LONWALL GUARD SP provides a durable protection without compromising aesthetic benefits. This strong and soft classic wood design panel is pleasing to the environment and extremely durable. These possessions are suitable for the high-traffic areas.

■ Features

- It has anti-bacterial and anti-fungal properties.
- It has a flexible shock absorbing surface that reduces the impact shock.
- It is extremely durable and performs well in high-traffic areas with minimal wear.
- It coordinates well with GUARD CORNER S and TRIM BELT M.
- Easey to fit and install with soft panel molding.
- It has classic design of natural wood grain pattern without repeat.

■ Specification

General name	Panel for antibacterial vinyl spandrel wall
Dimensions	2.0mm (thickness) × 303mm (width) × 1m (length)
Number of colors	7 colors
Packaging	10 pcs/case
Weight	1.0kg/m and about 11kg/case

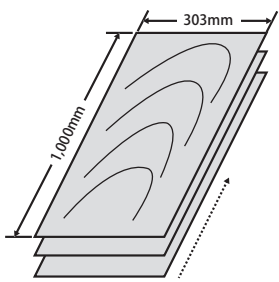

■ Color variations

7colors



GSP-2004



GSP-2025



GSP-2026



GSP-2007



GSP-2011



GSP-2012



GSP-2022

PIRICAMALL S



PIRICAMALL S is a high quality cove cap material for Lonseal vinyl sheet flooring that provides a perfect, professional finish. you can make any of the Lonseal product flooring edge new and modern looks.

■ Specification

General name	Parting material
Number of colors	8 colors
Packaging	2m×20 pcs/case

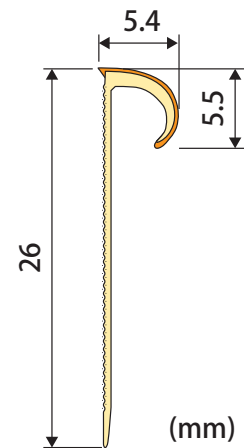

■ Color variations

8colors



PMS-1T



PMS-2T



PMS-3T



PMS-4T



PMS-5T



PMS-12T



PMS-13T



PMS-14T

PIRICAMALL S ACCESSORY

PIRICAMALL S ACCESSORY coordinates with PIRICAMALL S and is available in two versions, internal corner cove cap and external corner cove cap. These corner cove caps provide an exceptional professional finish irrespective of difficult installation area.

■ Specification

General name	external/internal corner material
Dimensions	100mm × 10 pcs/case
Packaging	10 pcs/case

External corner material

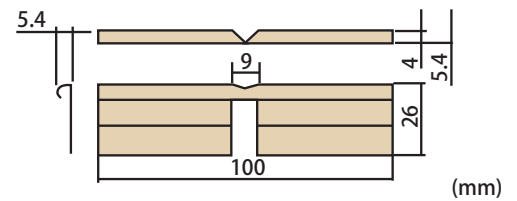

Internal corner material

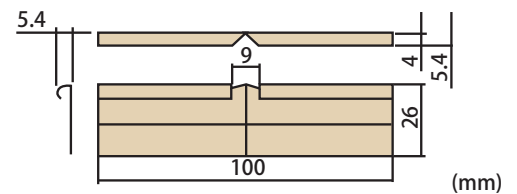

TRIM BELT M



TRIM BELT M coordinates with LONWALL GUARD series. It provides design flexibility. These high-quality trim materials can good match with the Lonseal flooring for a seamless. It also has shock absorbent, anti-bacterial, and anti-fungal properties.

■ Specification

General name	Antibacterial and antifungal soft decorative parting material
Dimensions	30mm (height) × 10m (length)
Number of colors	14 colors
Packaging	10m roll/case
Weight	1.25kg/case

Anti-bacterial Antifungal

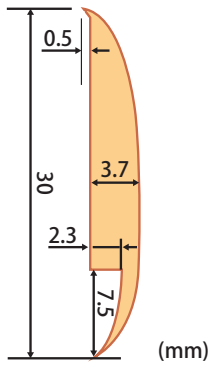

■ Color variations

14colors



TVM-2023

TVM-2025

TVM-2007

TVM-2012

TVM-2014

TVM-2016

TVM-2018

TVM-2004

TVM-2026

TVM-2011

TVM-2022

TVM-2015

TVM-2017

TVM-2019

CORNER GUARD S



CORNER GUARD S coordinates with the LONWALL GUARD series and gives a decorative, clean finished looks. It is engineered with a shock-absorption quality that can withstand massive abrasions and jolts in high-traffic areas.

■ Specification

General name	CORNER GUARD S
Dimensions	4mm (thickness) × 25mm × 25mm (width) × 1.2m (length)
Number of colors	14 colors
Packaging	10 rolls/case
Weight	4.0kg/case

Anti-bacterial

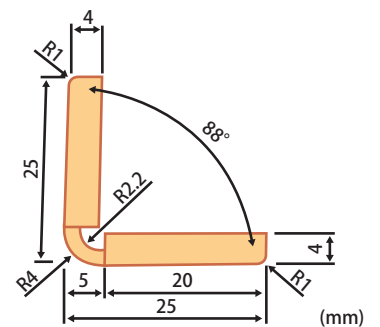

■ Color variations

14colors



GUARD CORNER S	GCS-2003	GCS-2004	GCS-2025	GCS-2006	GCS-2007	GCS-2011	GCS-2012
END CAP	GCC-2011	GCC-2005	GCC-2005	GCC-2005	GCC-2007	GCC-2011	GCC-2007



GUARD CORNER S	GCS-2013	GCS-2014	GCS-2015	GCS-2016	GCS-2017	GCS-2018	GCS-2019
END CAP	GCC-2011	GCC-203	GCC-203	GCC-2016	GCC-2005	GCC-2007	GCC-2016

LONSOFT SKIRTING BOARD



A decorative skirting board with a classic wood-grain design that coordinates with any of Lonseal's vinyl sheet flooring. LONSOFT SKIRTING BOARD is a durable and flexible vinyl skirting board that is easy to clean, scratch-resistant, and anti-bacterial.

■ Specification

General name	Antibacterial soft vinyl skirting board
Dimensions	60mm (height) × 914mm (length)
	75mm (height) × 914mm (length)
	100mm (height) × 914mm (length)
Number of colors	25 colors
Packaging	25 sheets/case

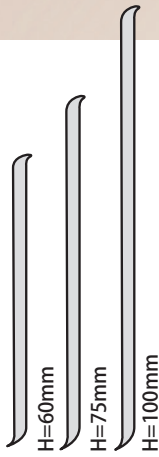

■ Color variations

25colors



* 25m/roll L type is also available. Change the color variation number from S-xxAB to L-xxAB.

LONSKIRTING BOARD WOODY

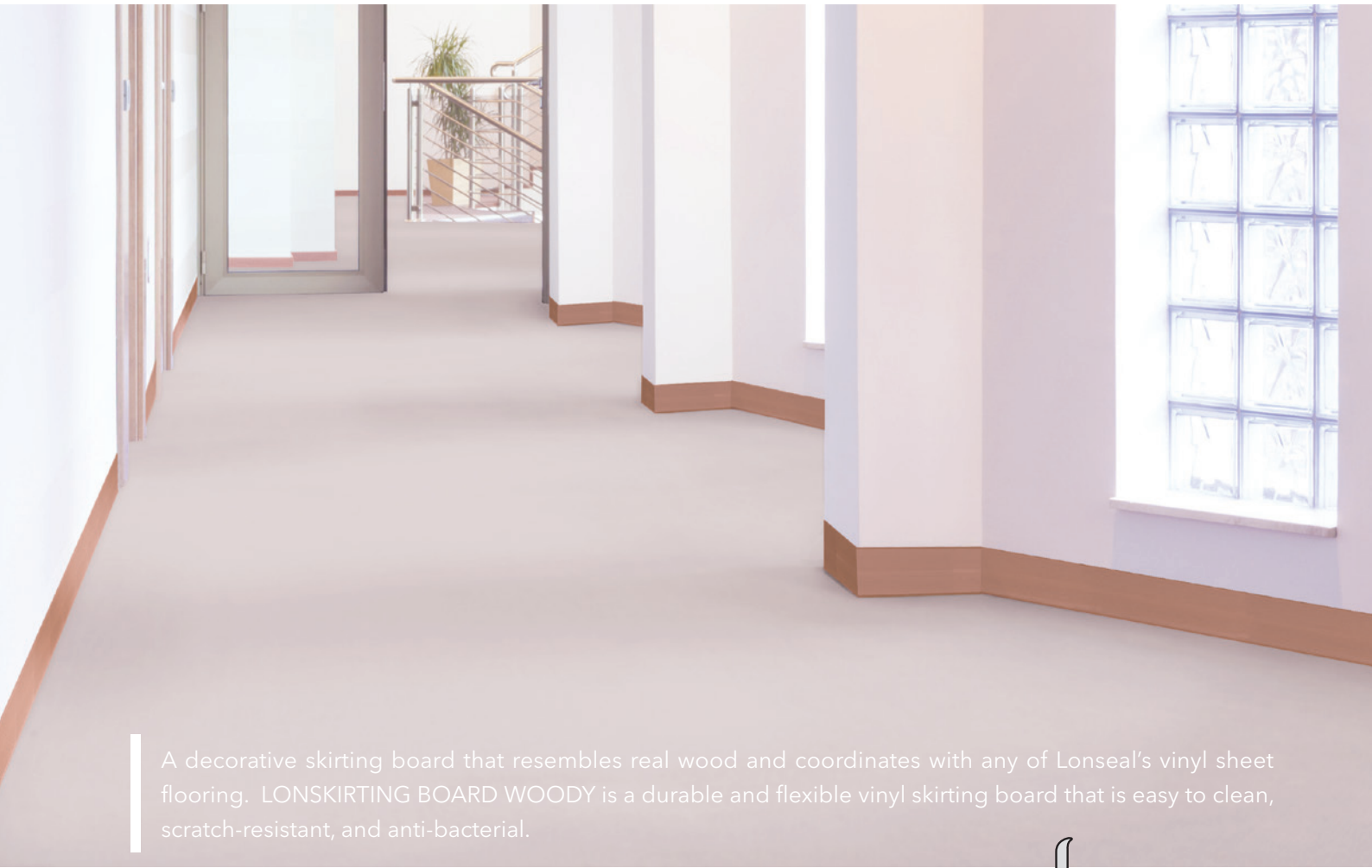

A decorative skirting board that resembles real wood and coordinates with any of Lonseal's vinyl sheet flooring. LONSKIRTING BOARD WOODY is a durable and flexible vinyl skirting board that is easy to clean, scratch-resistant, and anti-bacterial.

■ Specification

General name	Antibacterial soft vinyl skirting board
Dimensions	60mm (height) × 25m (length)
	75mm (height) × 25m (length)
	100mm (height) × 25m (length)
Number of colors	16 colors
Packaging	25m roll/case

Anti-bacterial

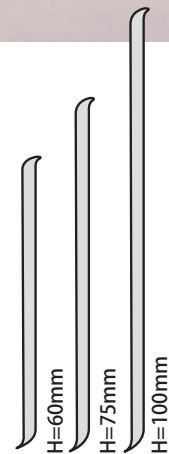

■ Color variations

16 colors



WIDE SKIRTING BOARD PLAIN

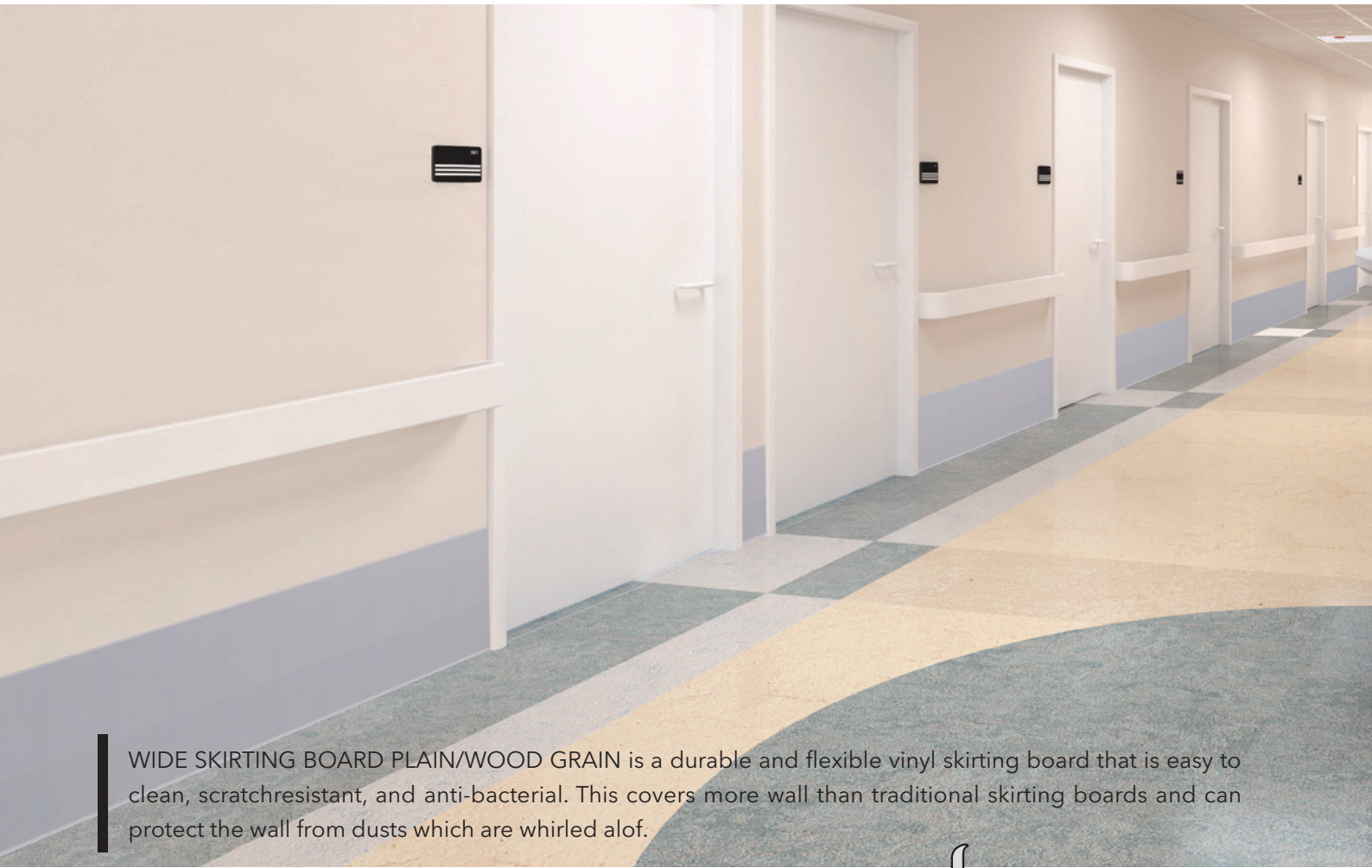

WIDE SKIRTING BOARD PLAIN/WOOD GRAIN is a durable and flexible vinyl skirting board that is easy to clean, scratchresistant, and anti-bacterial. This covers more wall than traditional skirting boards and can protect the wall from dusts which are whirled alof.

■ Specification

General name	Antibacterial wide soft vinyl skirting board
Dimensions	300mm (height) × 9m (length) 350mm (height) × 9m (length)
Number of colors	25 colors
Packaging	9m roll/case

Anti-bacterial

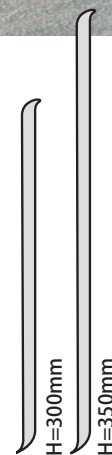

■ Color variations

25colors



WIDE SKIRTING BOARD WOODY



WIDE SKIRTING BOARD WOODY is designed with a natural wood look and is a durable and flexible vinyl skirting board that is easy to clean, scratchresistant, and anti-bacterial. This covers more wall than traditional skirting boards and can protect the wall from dusts which are whirled alof.

■ Specification

General name	Antibacterial wide soft vinyl skirting board
Dimensions	300mm (height) × 9m (length)
Number of colors	16 colors
Packaging	9m roll/case

Anti-bacterial

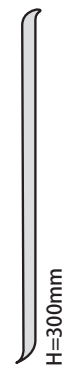

■ Color variations

16colors



LONSEAL FLOORING

GENERAL CATALOGUE VOL.4



 **LONSEAL CORPORATION**

6th Fl., Aste21 Bldg. 4-20-7 MIDORI, SUMIDA-KU, TOKYO, 130-0021 JAPAN

TEL:+81-3-5600-1803 FAX:+81-3-5600-1807

URL: www.lonseal.co.jp/english