

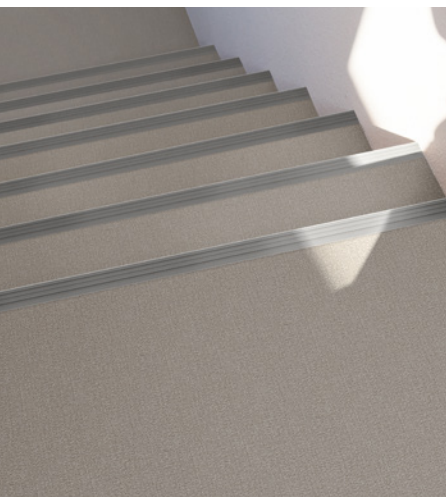

GENERAL CATALOGUE

VOL.6

LONSEAL FLOORING



LONSEAL FLOORING VOL. 6

INDEX

VINYL FLOOR SHEET	BASIC	
	LONLEUM PLAIN	P.6
	LONLEUM MARBLE	P.8
	LON MOKU	P.10
	ELBOUL	P.12
	SANITALEUM N	P.14
	ANTIVIRAL	
	LONLEUM PLAIN CT	P.16
	LONLEUM MARBLE CT	P.18
	LONLEUM OPSER CT	P.20
	LONLEUM TEXCLOUD CT	P.22
	LONLEUM SOULAGE CT	P.24
	LONLEUM RAMIE CT	P.26
	LONLEUM WOODY CT	P.28
	LON MOKU CT	P.30
	LON MOKU CT -REAL DESIGN-	P.32
	LON STONE CT	P.34
	LONLEUM COORDY CT	P.36
	LONPATIO CT	P.38
	LONPALETTE CT	P.40
	ANTIVIRAL & HIGHLY DURABLE	
	LONPROTECT MOKU	P.42
	LONPROTECT INLAID	P.44
	SANITALEUM ARPHA	P.46
	ANTIVIRAL (EXCEPT LONSAFE SHEET) & SHOCK ABSORPTION	
	LONFORM TEXCLOUD CT	P.48
	LONFORM OPSER CT	P.50
	LONFORM MOKU CT	P.52
	WELLEUM CT	P.54
	LONSAFE SHEET	P.56
	SLIP RESISTANT (INDOOR USE)	
	LONLAID AS	P.57
	LONLAID AS COMFORT	P.58
	LONMAT ME DIAMOND	P.60
	SLIP RESISTANT (OUTDOOR USE)	
	LONMAT ME TRICO	P.62
	LONMAT ME ARMO STONE	P.64
	LONMAT ME RANDOM HERRING	P.66
	LONMAT ME JASPER	P.68
	LONMAT ME PASELAT	P.70
	LONMAT ME ROZETA	P.72
	LONMAT ME HOLZWOOD	P.74
	LONMAT ME TWILL II	P.76
LONMAT ME SCORE	P.77	
LONMAT ME RESTARIA HS	P.78	
LONMAT ME RESTARIA SB	P.79	
STEP		
LONSTEP ME FZK EMOSS TYPE -TRICO TYPE-	P.80	
LONSTEP ME FZK EMOSS TYPE -JASPER TYPE-	P.82	
LONSTEP ME FZK FLAT TYPE -PASELAT TYPE-	P.83	
FUNCTIONAL		
LONSTAC R	P.84	
FA STAC R	P.85	
CD LEUM R	P.86	
TCD R	P.87	
ANTI CHEMICAL SUPERLEUM	P.88	
LONTILE OA MERAVYWOOD CT	P.90	
LONTILE OA IDEASTONE CT	P.92	
PERHOLON TILE CARPET LL-1100	P.94	
LONWALL GUARD L	P.96	
LONWALL GUARD SP	P.98	
TRIM BELT M	P.99	
CORNER GUARD S	P.100	
PIRICAMALL S	P.101	
LONSOFT SKIRTING BOARD/LON SKIRTING BOARD	P.102	
LON SKIRTING BOARD WOODY	P.103	
VINYL FLOOR TILE & CARPET TILE		
OTHERS		

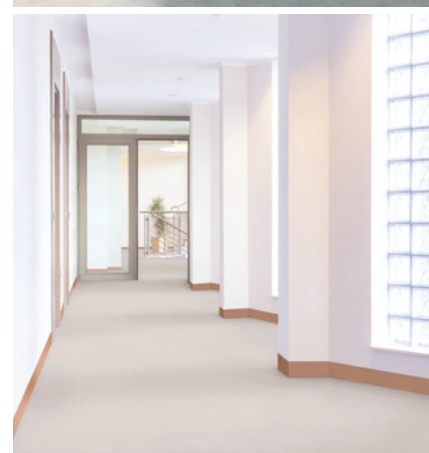

FUNCTIONS

		Product Name	Page	Antiviral	Anti-bacterial	Antifungal	Stain-resistant
							
VINYL FLOOR SHEET	BASIC	LONLEUM PLAIN	P.6		●		
		LONLEUM MARBLE	P.8		●		
		LON MOKU	P.10		●		
		ELBOUL	P.12		●		
		SANITALEUM N	P.14		●	●	●
	ANTIVIRAL	LONLEUM PLAIN CT	P.16	●	●		●
		LONLEUM MARBLE CT	P.18	●	●		●
		LONLEUM OPSEK CT	P.20	●	●		●
		LONLEUM TEXCLOUD CT	P.22	●	●		●
		LONLEUM SOULAGE CT	P.24	●	●		●
		LONLEUM RAMIE CT	P.26	●	●		●
		LONLEUM WOODY CT	P.28	●	●		●
		LON MOKU CT	P.30	●	●		●
		LON MOKU CT -REAL DESIGN-	P.32	●	●		●
		LON STONE CT	P.34	●	●		●
		LONLEUM COORDY CT	P.36	●	●		●
		LONPATIO CT	P.38	●	●		●
		LONPALETTE CT	P.40	●	●		●
	ANTIVIRAL & HIGHLY DURABLE	LONPROTECT MOKU	P.42	●	●		●
		LONPROTECT INLAID	P.44	●	●		●
		SANITALEUM ARPHA	P.46	●	●	●	●
	ANTIVIRAL (EXCEPT LONSAFE SHEET) & SHOCK ABSORPTION	LONFORM TEXCLOUD CT	P.48	●	●	●	●
		LONFORM OPSEK CT	P.50	●	●	●	●
		LONFORM MOKU CT	P.52	●	●	●	●
		WELLEUM CT	P.54	●	●	●	●
		LONSAFE SHEET	P.56				
	SLIP RESISTANT (INDOOR USE)	LONLAID AS	P.57		●	●	
		LONLAID AS COMFORT	P.58		●		
		LONMAT ME DIAMOND	P.60		●		
	SLIP RESISTANT (OUTDOOR USE)	LONMAT ME TRICO	P.62				
		LONMAT ME ARMO STONE	P.64				
		LONMAT ME RANDOM HERRING	P.66				
		LONMAT ME JASPER	P.68				
		LONMAT ME PASELAT	P.70				
		LONMAT ME ROZETA	P.72				
		LONMAT ME HOLZWOOD	P.74				
		LONMAT ME TWILL II	P.76				
		LONMAT ME SCORE	P.77				
		LONMAT ME RESTARIA HS	P.78		●		
		LONMAT ME RESTARIA SB	P.79		●		
	STEP	LONSTEP ME FZK EMBOSS TYPE -TRICO TYPE-	P.80				
		LONSTEP ME FZK EMBOSS TYPE -JASPER TYPE-	P.82				
		LONSTEP ME FZK FLAT TYPE -PASELAT TYPE-	P.83				
	FUNCTIONAL	LONSTAC R	P.84		●		
		FA STAC R	P.85		●		
CD LEUM R		P.86		●			
TCD R		P.87		●			
ANTI CHEMICAL SUPERLEUM		P.88		●			
VINYL FLOOR TILE & CARPET TILE	LONTILE OA MERAVYWOOD CT	P.90				●	
	LONTILE OA IDEASTONE CT	P.92				●	
	PERHOLON TILE CARPET LL-1100	P.94					
OTHERS	LONWALL GUARD L	P.96	●	●	●		
	LONWALL GUARD SP	P.98		●	●		
	TRIM BELT M	P.99		●	●		
	CORNER GUARD S	P.100					
	PIRICAMALL S	P.101					
	LONSOFT SKIRTING BOARD/LON SKIRTING BOARD	P.102		●			
	LON SKIRTING BOARD WOODY	P.103		●			

Let's take antivirus measures with LONSEAL's flooring!

~ LONSEAL's flooring is useful in various places ~

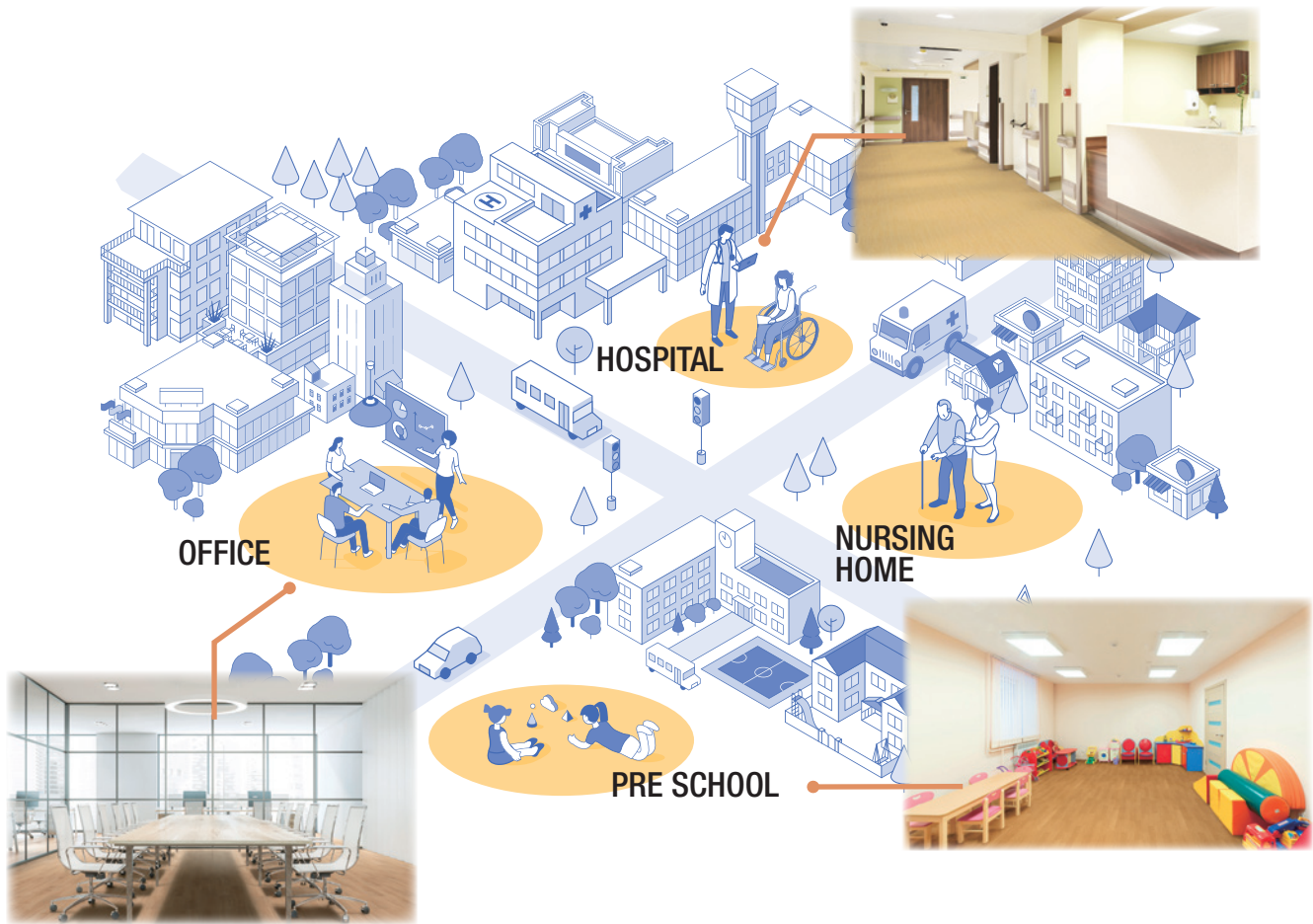

● The process of virus infection spreading

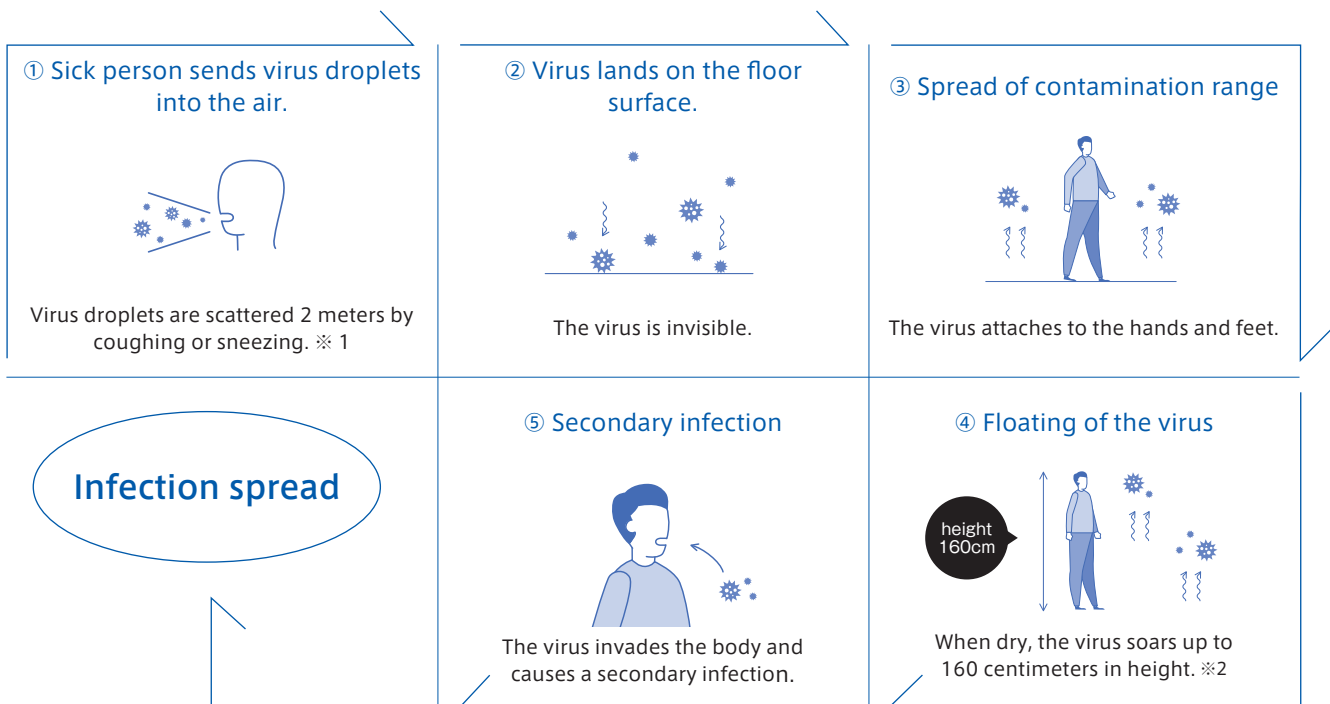

※ 1 Quote source : Institute of Physical and Chemical Research

※ 2 Quote source : Norovirus measures Emergency Task Force (Tokyo Metropolitan Institute of Public Health)

● Antiviral technology is used for the coating layer.

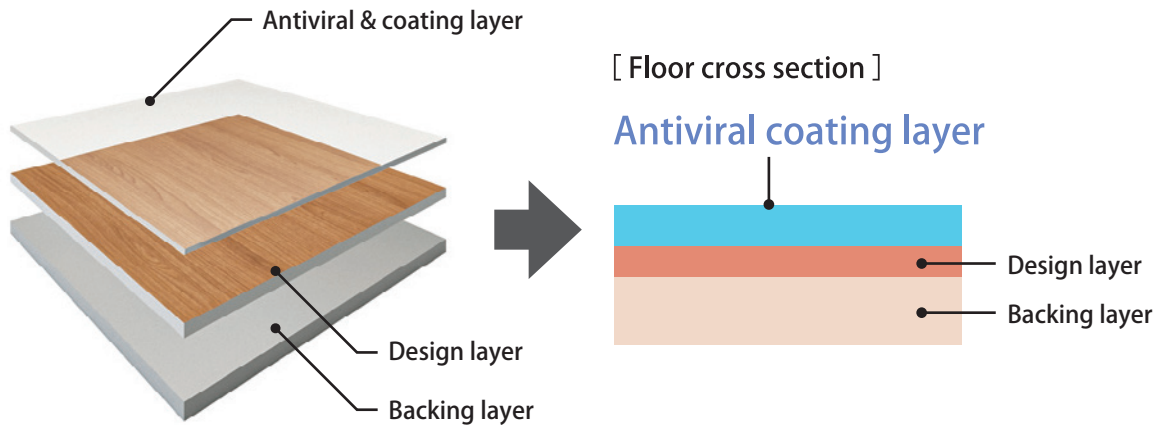

LONSEAL's flooring achieves high durability with an antiviral coating layer.

Test
Stain resistance test (Scuff marks by shoe soles)

Antiviral coating layer

General coating layer

Test method: JIS K 3920 (Results equivalent to 10,000 people walking)

● Up to 99% reduction of viral activity within 24 hours.

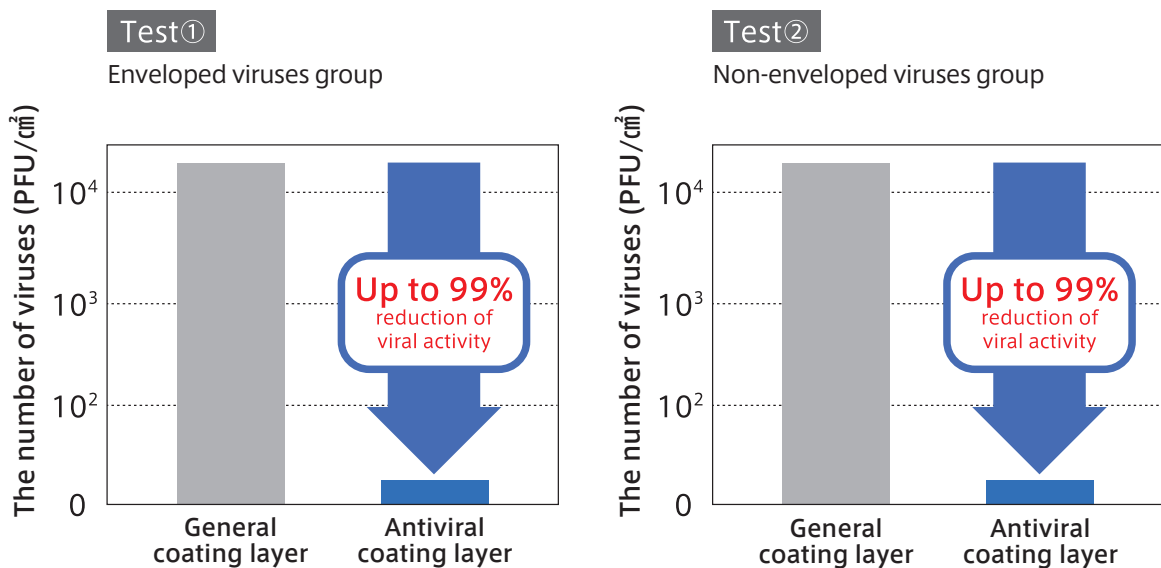

Testing institution : Japan Textile Products Quality and Technology Center

Test method : ISO21702

- This verification is by the testing institute. The effect may vary depending on the conditions of use and the method of use.
- This product is not intended for pharmaceuticals, or medical purposes, and does not guarantee infection prevention.

LONLEUM PLAIN



3051-3116

■ Features

Beautiful plain-colored vinyl floor sheet with a high gloss surface.

- It reduces leg fatigue by flexible shock absorbing surface.
- Extremely durable performance is suitable for high-traffic areas.
- Easy to install, so it fits easily into the location.

■ Specification

General name	Vinyl floor sheet (JIS A 5705)
Dimensions	2.0mm (thickness) × 1,820mm (width) × 9m (length)
Number of colors	24 colors
Packaging	9m/roll
Weight	3.3kg/m ² , 54kg/roll



■ Color variations

24colors

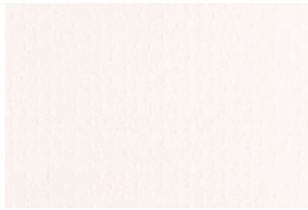

3907



3054



3056



3022

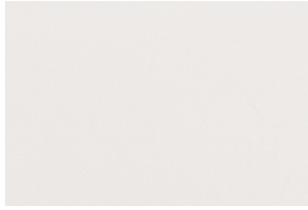

3051

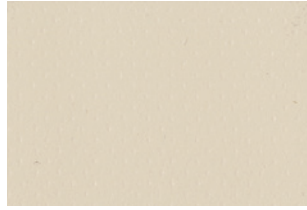

3159



3025



3102



3902



3301



3057



3053



3140



3134



3138



3059



3116



3113



3510



3610

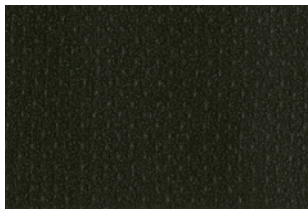

3906



3308



3058



3060

LONLEUM MARBLE



5598

■ Features

Simple and soft-image vinyl floor sheet with a marble pattern.

- It reduces leg fatigue by flexible shock absorbing surface.
- Extremely durable performance is suitable for high-traffic areas.
- Easy to install, so it fits easily into the location.

■ Specification

General name	Vinyl floor sheet (JIS A 5705)
Dimensions	2.0mm (thickness) × 1,820mm (width) × 9m (length)
Number of colors	28 colors
Packaging	9m/roll
Weight	3.3kg/m ² , 54kg/roll



■ Color variations

28colors

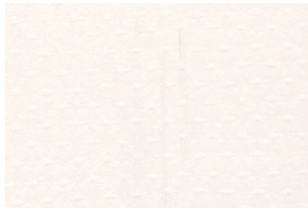

5801



5401



5202



5301



5023



5598



5407



5026



5902



5588



5028



5102



5140



5029



5030



5027



5024



5562



5031



5613

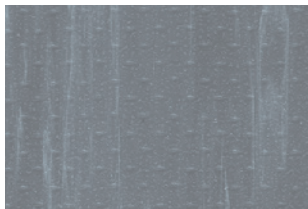

5116

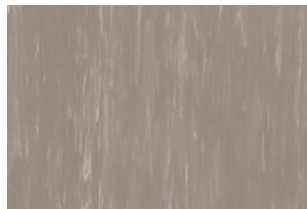

5307



5589

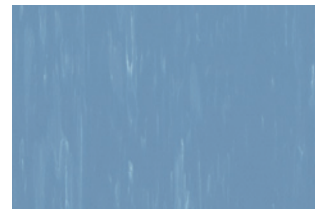

5033

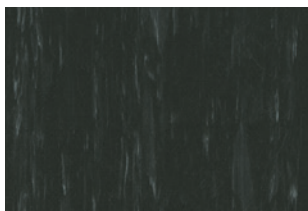

5906

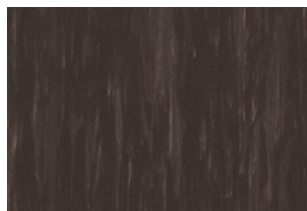

5308

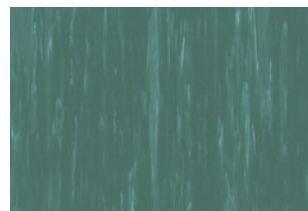

5119

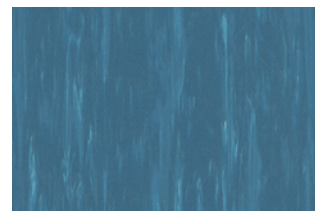

5612

LON MOKU



MK-1851

■ Features

Stylish-image vinyl floor sheet with a wood grain pattern.

- It reduces leg fatigue by flexible shock absorbing surface.
- Extremely durable performance is suitable for high-traffic areas.
- Easy to install, so it fits easily into the location.

■ Specification

General name	Vinyl floor sheet (JIS A 5705)
Dimensions	2.0mm (thickness) × 1,820mm (width) × 9m (length)
Number of colors	5 colors
Packaging	9m/roll
Weight	3.0kg/m ² , 49kg/roll

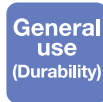

■ Color variations

5 colors

Oak



MK-1805



MK-1801



MK-1802

MK-1802

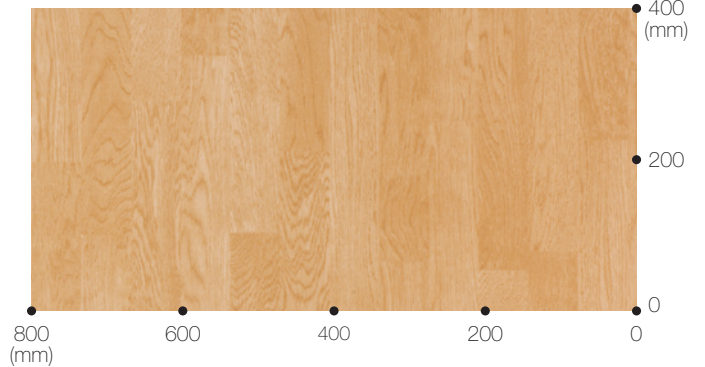

Cherry



MK-1851



MK-1852

MK-1852



ELBOUL



■ Features

Highly fashionable vinyl floor sheet with a unique texture.

- It reduces leg fatigue by flexible shock absorbing surface.
- Extremely durable performance is suitable for high-traffic areas.
- Easy to install, so it fits easily into the location.

■ Specification

General name	Vinyl floor sheet (JIS A 5705)
Dimensions	2.0mm (thickness) × 1,820mm (width) × 9m (length)
Number of colors	8 colors
Packaging	9m/roll
Weight	3.0kg/m ² , 50kg/roll

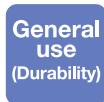

■ Color variations

8 colors

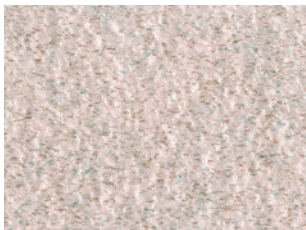

7 Pearl pink



4 Pearl beige



5 Light brown



6 Brown

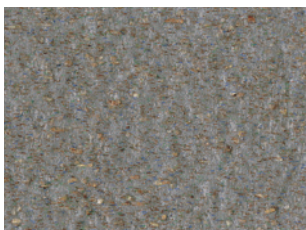

2 Dark gray



3 Warm gray

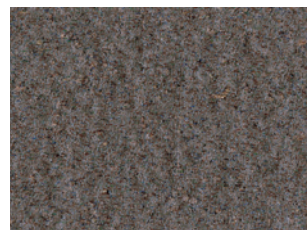

12 Purplish gray

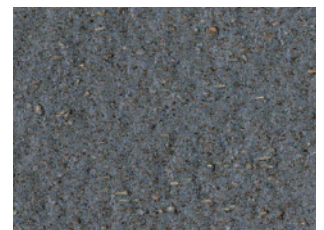

15 Blue purplish gray

SANITALEUM N

HIGHLY DURABLE



SL-8001 · SL-8003

■ Features

Highly durable vinyl floor sheet with much color variations.

- It offers super stain-resistant.
- No need to apply the floor polish on the surface.
- It has excellent chemical-resistant such as acid and alkaline.
- It reduces leg fatigue by flexible shock absorbing surface.
- Extremely durable performance is suitable for high-traffic areas.

■ Specification

General name	Low-maintenance vinyl floor sheet(JIS A 5705)
Dimensions	2.0mm (thickness) × 1,820mm (width) × 9m (length)
Number of colors	24 colors
Packaging	9m/roll
Weight	3.1kg/m ² , 51kg/roll

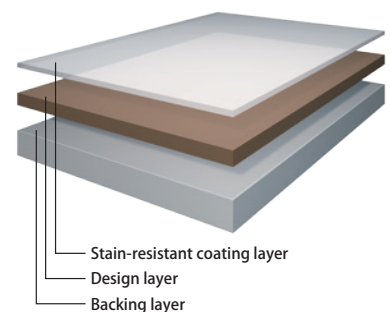

■ Color variations

24colors

Abstract pattern



SL-8004



SL-8001



SL-8011



SL-8012



SL-8005



SL-8002



SL-8009



SL-8010



SL-8006

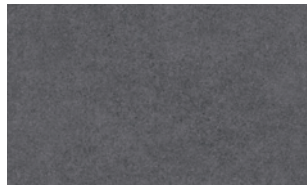

SL-8003



SL-8014

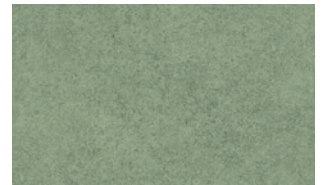

SL-8015



SL-8007

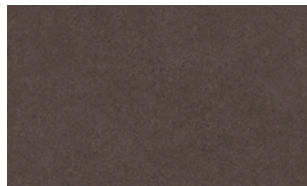

SL-8008



SL-8013

Wood grain pattern



SL-1801



SL-1802



SL-1836



SL-1832

Fabric pattern



SL-2212

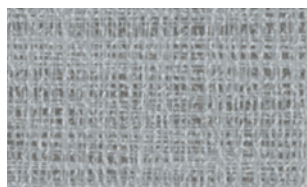

SL-2202



SL-2206



SL-2203

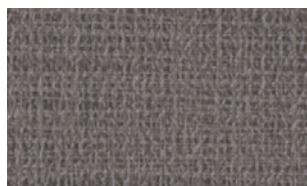

SL-2207

LONLEUM PLAIN CT ANTIVIRAL



3907CT-3116CT

■ Features

Beautiful plain-colored antiviral vinyl floor sheet.

- No need to apply the floor polish on the surface.
- It reduces viral activity of enveloped viruses and non-enveloped viruses by up to 99%.
- It has excellent chemical-resistant such as acid and alkaline.
- It reduces leg fatigue by flexible shock absorbing surface.
- Extremely durable performance is suitable for high-traffic areas.

■ Specification

General name	Antiviral&Low-maintenance vinyl floor sheet(JIS A 5705)
Dimensions	2.0mm (thickness) × 1,820mm (width) × 9m (length)
Number of colors	24 colors
Packaging	9m/roll
Weight	3.3kg/m ² , 54kg/roll

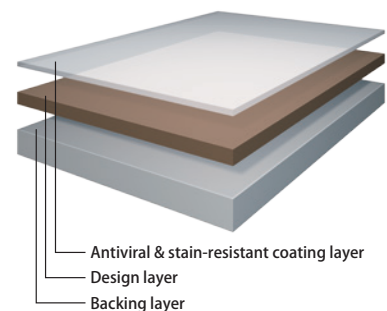

Antiviral & stain-resistant coating layer
Design layer
Backing layer



■ Color variations

24colors

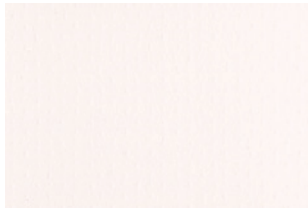

3907CT



3054CT



3056CT



3022CT

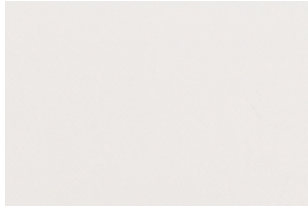

3051CT

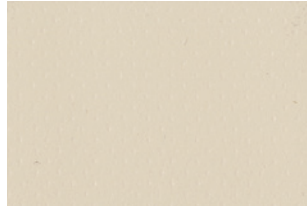

3159CT



3025CT



3102CT



3902CT



3301CT



3057CT



3053CT



3140CT



3134CT



3138CT



3059CT



3116CT



3113CT



3510CT



3610CT

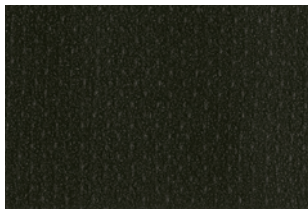

3906CT

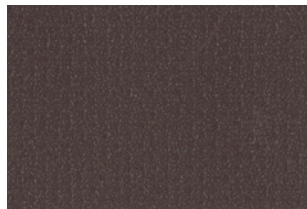

3308CT



3058CT



3060CT

LONLEUM MARBLE CT ANTIVIRAL



5023CT

■ Features

Simple and soft-image antiviral vinyl floor sheet with a marble pattern.

- No need to apply the floor polish on the surface.
- It reduces viral activity of enveloped viruses and non-enveloped viruses by up to 99%.
- It has excellent chemical-resistant such as acid and alkaline.
- It reduces leg fatigue by flexible shock absorbing surface.
- Extremely durable performance is suitable for high-traffic areas.

■ Specification

General name	Antiviral&Low-maintenance vinyl floor sheet(JIS A 5705)
Dimensions	2.0mm (thickness) × 1,820mm (width) × 9m (length)
Number of colors	28 colors
Packaging	9m/roll
Weight	3.3kg/m ² , 54kg/roll

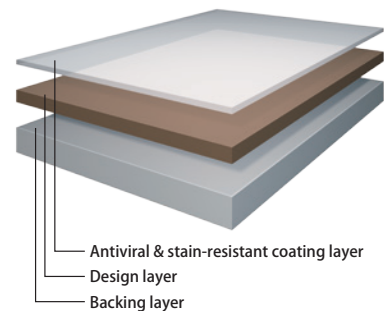

■ Color variations

28colors



5801CT



5401CT



5202CT



5301CT



5023CT



5598CT



5407CT



5026CT



5902CT



5588CT



5028CT



5102CT



5140CT



5029CT



5030CT



5027CT



5024CT



5562CT



5031CT



5613CT

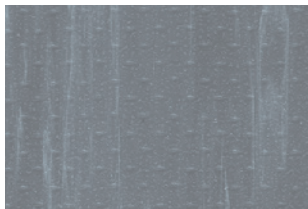

5116CT



5307CT



5589CT

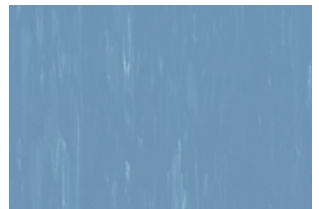

5033CT

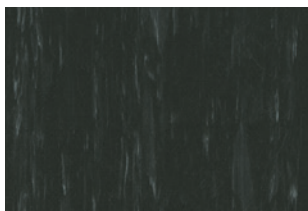

5906CT

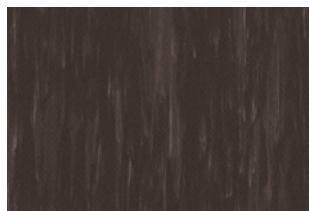

5308CT

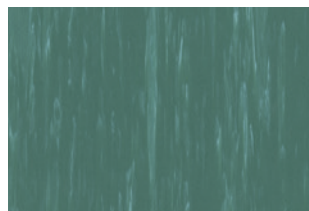

5119CT

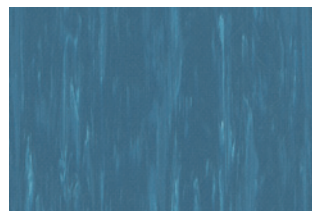

5612CT

LONLEUM OPSER CT **ANTIVIRAL**



OPC-8004

■ Features

Soft-image antiviral vinyl floor sheet with a natural stone pattern.

- No need to apply the floor polish on the surface.
- It reduces viral activity of enveloped viruses and non-enveloped viruses by up to 99%.
- It has excellent chemical-resistant such as acid and alkaline.
- It reduces leg fatigue by flexible shock absorbing surface.
- Extremely durable performance is suitable for high-traffic areas.

■ Specification

General name	Antiviral&Low-maintenance vinyl floor sheet(JIS A 5705)
Dimensions	2.0mm (thickness) × 1,820mm (width) × 9m (length)
Number of colors	15 colors
Packaging	9m/roll
Weight	3.0kg/m ² , 49kg/roll

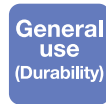
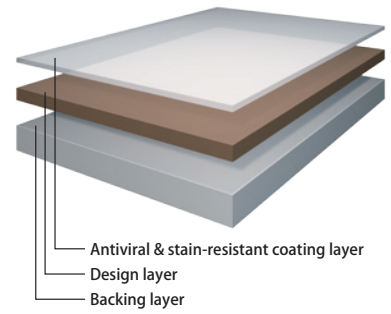

■ Color variations

15colors



OPC-8001

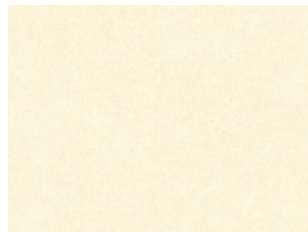

OPC-8004



OPC-8011



OPC-8009



OPC-8002



OPC-8005



OPC-8012



OPC-8010

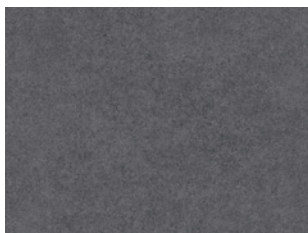

OPC-8003



OPC-8006



OPC-8014

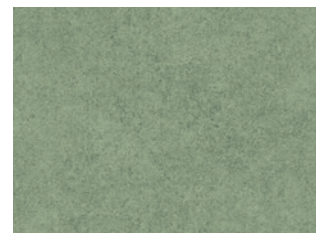

OPC-8015

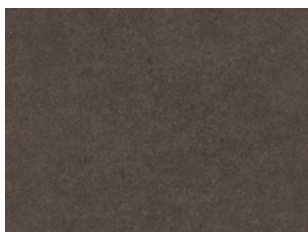

OPC-8008



OPC-8007



OPC-8013

LONLEUM TEXCLOUD CT ANTIVIRAL



■ Features

Soft-image antiviral vinyl floor sheet with a fiber and a abstract pattern.

- No need to apply the floor polish on the surface.
- It reduces viral activity of enveloped viruses and non-enveloped viruses by up to 99%.
- It has excellent chemical-resistant such as acid and alkaline.
- It reduces leg fatigue by flexible shock absorbing surface.
- Extremely durable performance is suitable for high-traffic areas.

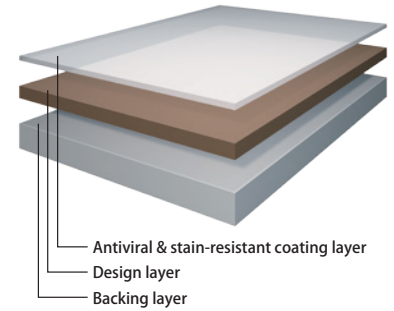

■ Specification

General name	Antiviral&Low-maintenance vinyl floor sheet(JIS A 5705)
Dimensions	2.0mm(thickness)×1,820mm(width)×9m (length)
Number of colors	10 colors
Packaging	9m/roll
Weight	3.1kg/m ² ,50.8kg/roll

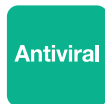

■ Color variations

10colors



TCC-7001

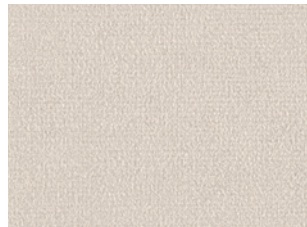

TCC-7004



TCC-7007



TCC-7009



TCC-7003



TCC-7005



TCC-7008



TCC-7010



TCC-7002



TCC-7006

LONLEUM SOULAGE CT **ANTIVIRAL**



■ Features

Calm-image antiviral vinyl floor sheet with a carpet-like fiber pattern.

- No need to apply the floor polish on the surface.
- It reduces viral activity of enveloped viruses and non-enveloped viruses by up to 99%.
- It has excellent chemical-resistant such as acid and alkaline.
- It reduces leg fatigue by flexible shock absorbing surface.
- Extremely durable performance is suitable for high-traffic areas.

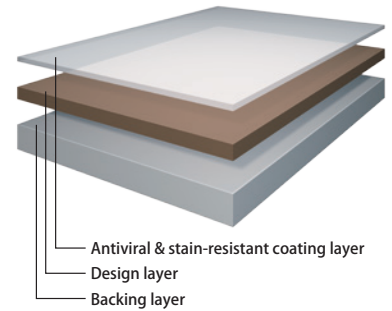

■ Specification

General name	Antiviral&Low-maintenance vinyl floor sheet(JIS A 5705)
Dimensions	2.0mm(thickness)×1,820mm(width)×9m (length)
Number of colors	5 colors
Packaging	9m/roll
Weight	3.1kg/m ² ,51kg/roll

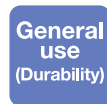
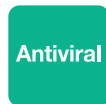

■ Color variations

5colors



SRC-7105



SRC-7101



SRC-7102



SRC-7103



SRC-7104

LONLEUM RAMIE CT **ANTIVIRAL**



RAC-2201

■ Features

Calm-image antiviral vinyl floor sheet with a fiber pattern.

- No need to apply the floor polish on the surface.
- It reduces viral activity of enveloped viruses and non-enveloped viruses by up to 99%.
- It has excellent chemical-resistant such as acid and alkaline.
- It reduces leg fatigue by flexible shock absorbing surface.
- Extremely durable performance is suitable for high-traffic areas.

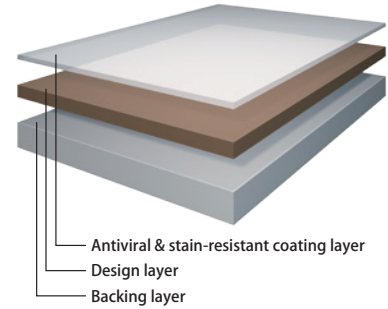

■ Specification

General name	Antiviral&Low-maintenance vinyl floor sheet(JIS A 5705)
Dimensions	2.0mm (thickness) × 1,820mm (width) × 9m (length)
Number of colors	13 colors
Packaging	9m/roll
Weight	3.1kg/m ² , 51kg/roll



■ Color variations

13colors



RAC-2212



RAC-2203



RAC-2213

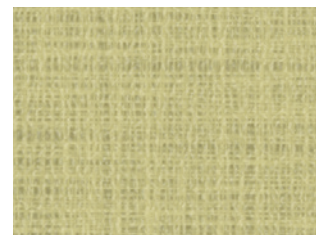

RAC-2209



RAC-2201



RAC-2204



RAC-2208

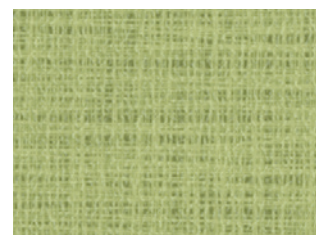

RAC-2210

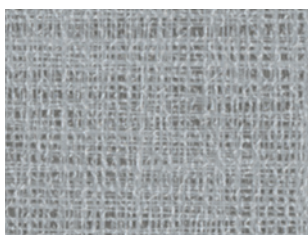

RAC-2202

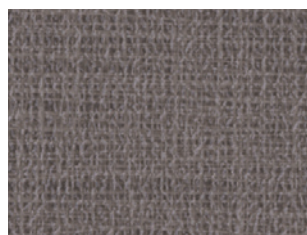

RAC-2207

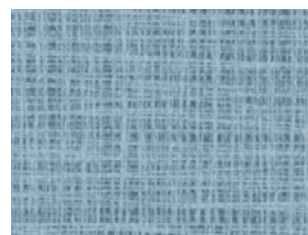

RAC-2211

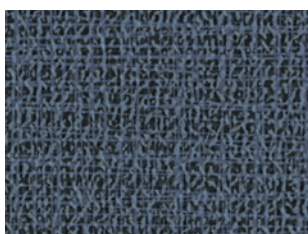

RAC-2206



RAC-2205

LONLEUM WOODY CT **ANTIVIRAL**



■ Features

Antiviral vinyl floor sheet with a wood grain-like pattern.

- No need to apply the floor polish on the surface.
- It reduces viral activity of enveloped viruses and non-enveloped viruses by up to 99%.
- It has excellent chemical-resistant such as acid and alkaline.
- It reduces leg fatigue by flexible shock absorbing surface.
- Extremely durable performance is suitable for high-traffic areas.

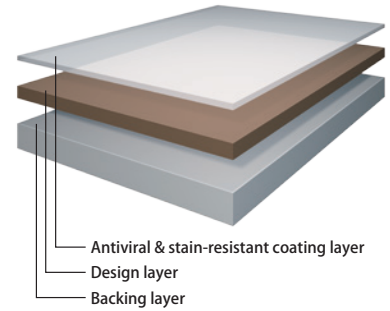

■ Specification

General name	Antiviral&Low-maintenance vinyl floor sheet(JIS A 5705)
Dimensions	2.0mm (thickness) × 1,820mm (width) × 9m (length)
Number of colors	6 colors
Packaging	9m/roll
Weight	3.3kg/m ² , 54kg/roll

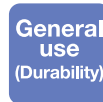

■ Color variations

6colors



WDC-6301



WDC-6302



WDC-6303

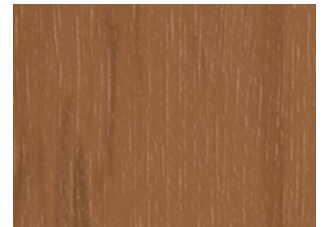

WDC-6304



WDC-6305



WDC-6307

LON MOKU CT ANTIVIRAL



MKC-1852

■ Features

Stylish-image antiviral vinyl floor sheet with a wood grain pattern.

- No need to apply the floor polish on the surface.
- It reduces viral activity of enveloped viruses and non-enveloped viruses by up to 99%.
- It has excellent chemical-resistant such as acid and alkaline.
- It reduces leg fatigue by flexible shock absorbing surface.
- Extremely durable performance is suitable for high-traffic areas.

■ Specification

General name	Antiviral&Low-maintenance vinyl floor sheet(JIS A 5705)
Dimensions	2.0mm (thickness) × 1,820mm (width) × 9m (length)
Number of colors	20 colors
Packaging	9m/roll
Weight	2.9kg/m ² , 48kg/roll

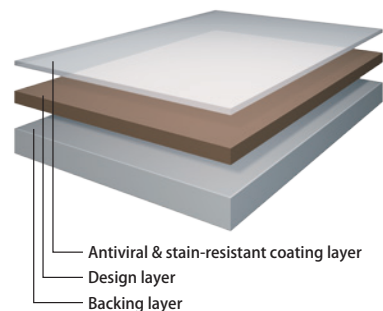

■ Color variations

20colors

Oak



MKC-1805



MKC-1806



MKC-1807



MKC-1801



MKC-1802



MKC-1803

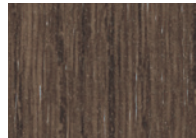

MKC-1808

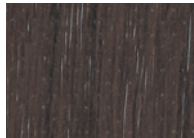

MKC-1804

MKC-1802

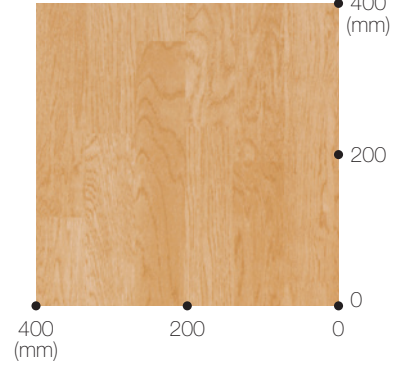

Walnut



MKC-1838

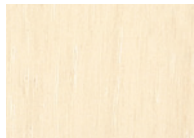

MKC-1837



MKC-1836



MKC-1835



MKC-1834



MKC-1833



MKC-1832

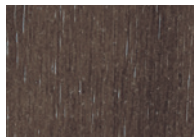

MKC-1831

MKC-1833

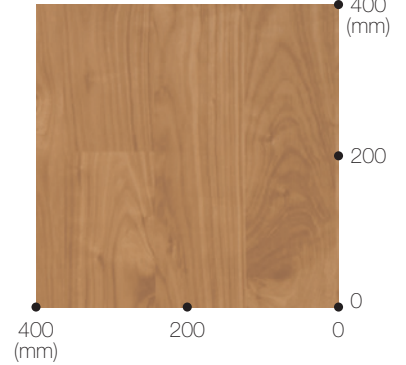

Cherry



MKC-1851



MKC-1852



MKC-1853

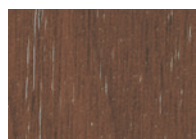

MKC-1854

MKC-1852

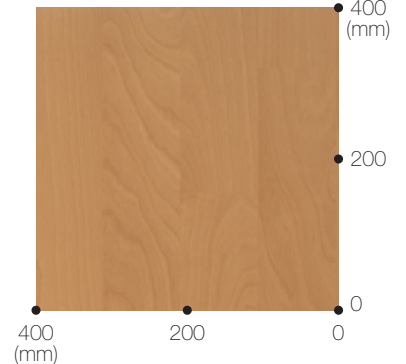

LON MOKU CT -REAL DESIGN- ANTIVIRAL



MKC-1815

■ Features

LON MOKU CT with an authentic image of a wood grain pattern by surface embossing.

- No need to apply the floor polish on the surface.
- It reduces viral activity of enveloped viruses and non-enveloped viruses by up to 99%.
- It has excellent chemical-resistant such as acid and alkaline.
- It reduces leg fatigue by flexible shock absorbing surface.
- Extremely durable performance is suitable for high-traffic areas.

■ Specification

General name	Antiviral&Low-maintenance vinyl floor sheet(JIS A 5705)
Dimensions	2.0mm (thickness) × 1,820mm (width) × 9m (length)
Number of colors	14 colors
Packaging	9m/roll
Weight	2.9kg/m ² , 48kg/roll

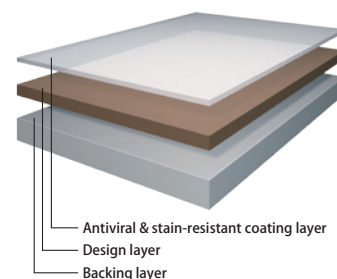

■ Color variations

14colors

Natural Oak



MKC-1811



MKC-1812



MKC-1813



MKC-1814

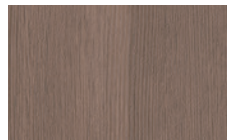

MKC-1815

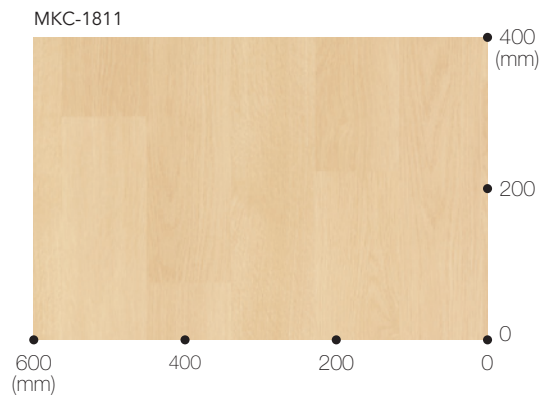

Chic Walnut



MKC-1841



MKC-1842

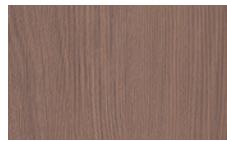

MKC-1843



MKC-1844

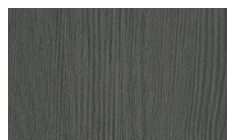

MKC-1845



White Ash



MKC-1861



MKC-1862



MKC-1863



MKC-1864

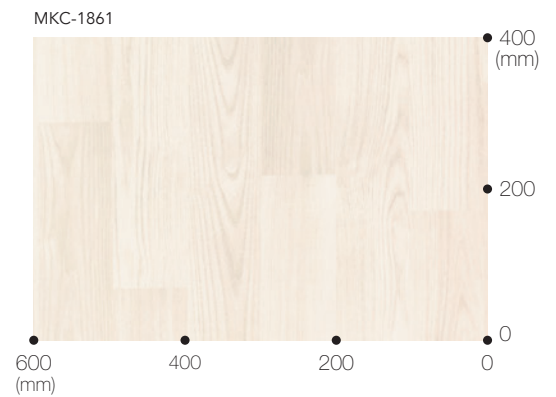

LON STONE CT **ANTIVIRAL**



STC-2001

■ Features

Stylish-image antiviral vinyl floor sheet with a stone grain pattern.

- No need to apply the floor polish on the surface.
- It reduces viral activity of enveloped viruses and non-enveloped viruses by up to 99%.
- It has excellent chemical-resistant such as acid and alkaline.
- It reduces leg fatigue by flexible shock absorbing surface.

■ Specification

General name	Antiviral&Low-maintenance vinyl floor sheet(JIS A 5705)
Dimensions	2.0mm(thickness)×1,820mm(width)×9m(length)
Number of colors	10 colors
Packaging	9m/roll
Weight	(Limestone)3.0kg/m ² ,49kg/roll (Bianco Carrara&Onyx)3.2kg/m ² ,52kg/roll

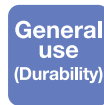
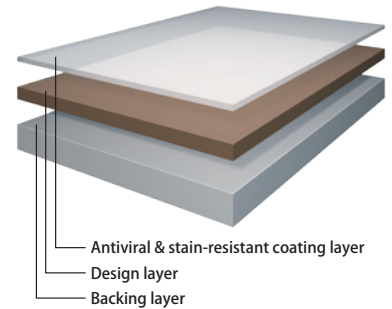

■ Color variations

10colors

Limestone

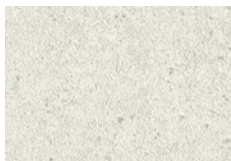

STC-1004

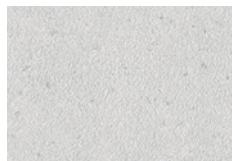

STC-1001



STC-1005



STC-1006



STC-1002



STC-1003

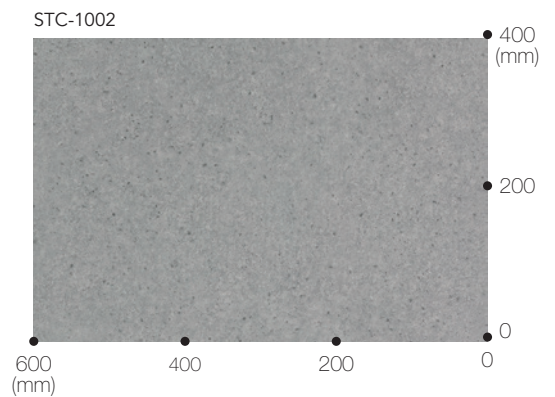

Bianco Carrara



STC-2001



STC-2002

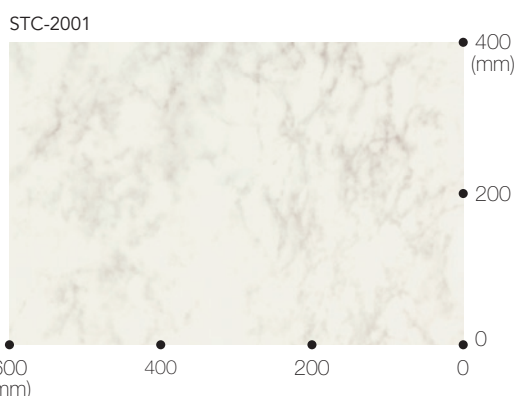

Onyx



STC-3001



STC-3002

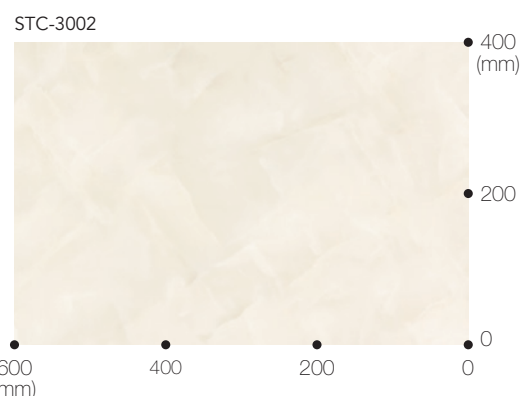

LONLEUM COORDY CT ANTIVIRAL



COC-6201·COC-6222

■ Features

Pastel-colored antiviral vinyl floor sheet with a stone grain pattern.

- No need to apply the floor polish on the surface.
- It reduces viral activity of enveloped viruses and non-enveloped viruses by up to 99%.
- It has excellent chemical-resistant such as acid and alkaline.
- It reduces leg fatigue by flexible shock absorbing surface.
- Extremely durable performance is suitable for high-traffic areas.

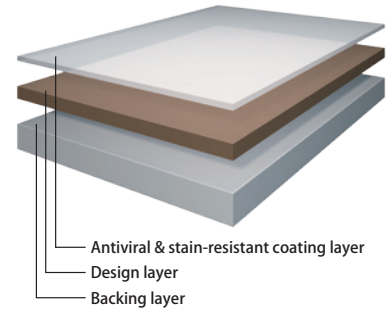

■ Specification

General name	Antiviral&Low-maintenance vinyl floor sheet(JIS A 5705)
Dimensions	2.0mm (thickness) × 1,820mm (width) × 9m (length)
Number of colors	10 colors
Packaging	9m/roll
Weight	3.1kg/m ² , 51kg/roll

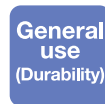
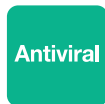

■ Color variations

10colors



COC-6201



COC-6202



COC-6211



COC-6212



COC-6221



COC-6222

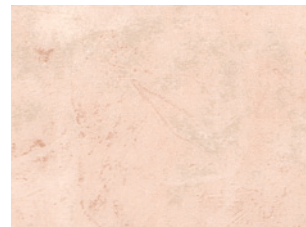

COC-6231



COC-6232



COC-6241



COC-6242

LONPATIO CT ANTIVIRAL



PMC-1102

■ Features

Beautiful antiviral vinyl floor sheet with a granite grain pattern.

- No need to apply the floor polish on the surface.
- It reduces viral activity of enveloped viruses and non-enveloped viruses by up to 99%.
- It has excellent chemical-resistant such as acid and alkaline.
- It reduces leg fatigue by flexible shock absorbing surface.
- Extremely durable performance is suitable for high-traffic areas.

■ Specification

General name	Antiviral&Low-maintenance vinyl floor sheet(JIS A 5705)
Dimensions	2.0mm (thickness) × 1,820mm (width) × 9m (length)
Number of colors	13 colors
Packaging	9m/roll
Weight	3.0kg/m ² , 49kg/roll

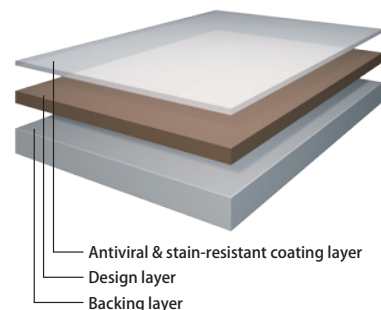

■ Color variations

13colors

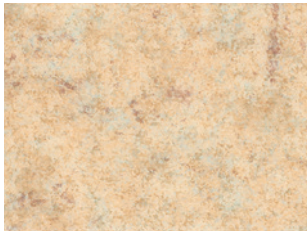

PMC-1103

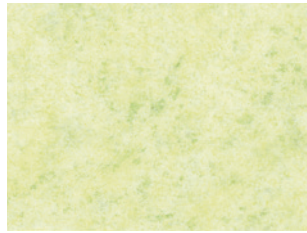

PMC-1113

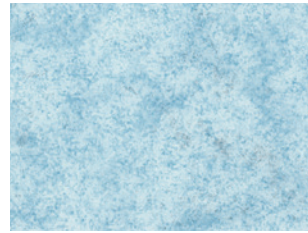

PMC-1112



PMC-1111



PMC-1104

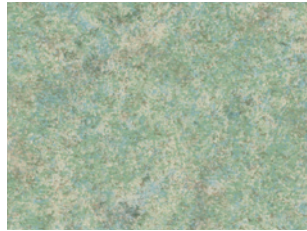

PMC-1108

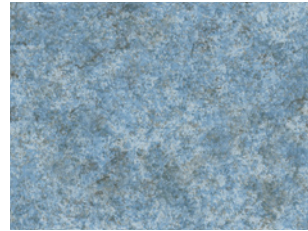

PMC-1109

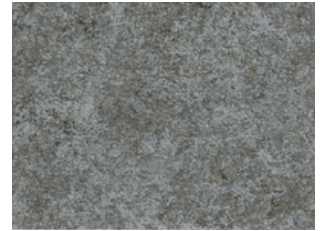

PMC-1102



PMC-1105



PMC-1107



PMC-1101



PMC-1110



PMC-1106

Antiviral activity

In general terms, when a virus is inactivated, it disrupts its original growth cycle.

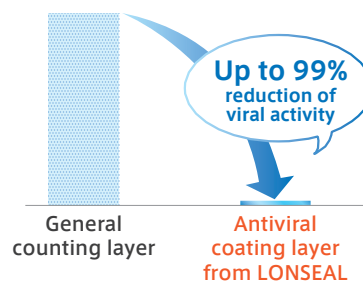
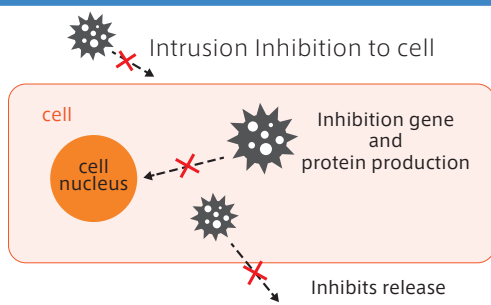

LONSEAL flooring has the uniform layer, so antiviral properties are effective in the long run.

LONPALETTE CT ANTIVIRAL



LPC-1309·LPC-1314

■ Features

Beautiful antiviral vinyl floor sheet with a balanced abstract pattern.

- No need to apply the floor polish on the surface.
- It reduces viral activity of enveloped viruses and non-enveloped viruses by up to 99%.
- It has excellent chemical-resistant such as acid and alkaline.
- It reduces leg fatigue by flexible shock absorbing surface.
- Extremely durable performance is suitable for high-traffic areas.

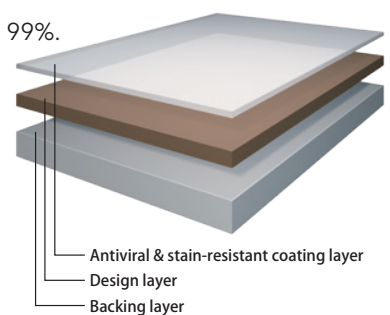

■ Specification

General name	Antiviral&Low-maintenance vinyl floor sheet(JIS A 5705)
Dimensions	2.0mm (thickness) × 1,820mm (width) × 9m (length)
Number of colors	20 colors
Packaging	9m/roll
Weight	3.0kg/m ² , 49kg/roll



JIS A 5705
QA0307072



15%
recycled
(Act on promoting
Green procurement)

LOW
VOC

Antiviral

Anti-
bacterial

Stain
resistant

Chemical
resistant

General
use
(Durability)

■ Color variations

20colors



LPC-1301



LPC-1306



LPC-1311



LPC-1316



LPC-1302

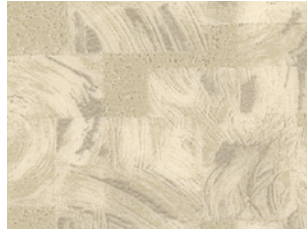

LPC-1307



LPC-1312



LPC-1317

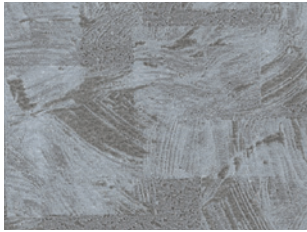

LPC-1303



LPC-1308



LPC-1313

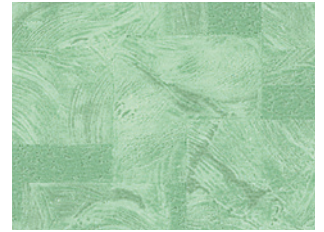

LPC-1318



LPC-1304



LPC-1309



LPC-1314



LPC-1319

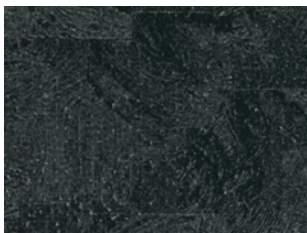

LPC-1305

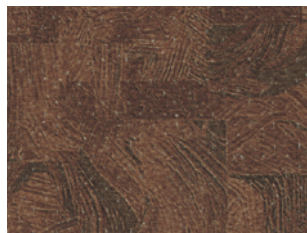

LPC-1310

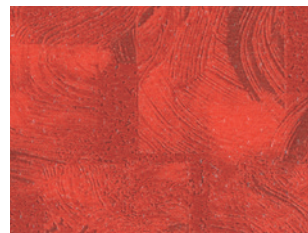

LPC-1315



LPC-1320

LONPROTECT MOKU

ANTIVIRAL & HIGHLY DURABLE



PRM-1801

■ Features

Highly durable antiviral vinyl floor sheet with a wood grain pattern.

- No need to apply the floor polish on the surface.
- It reduces viral activity of enveloped viruses and non-enveloped viruses by up to 99%.
- It has excellent chemical-resistant such as acid and alkaline.
- It reduces leg fatigue by flexible shock absorbing surface.
- Extremely durable performance is suitable for high-traffic areas.

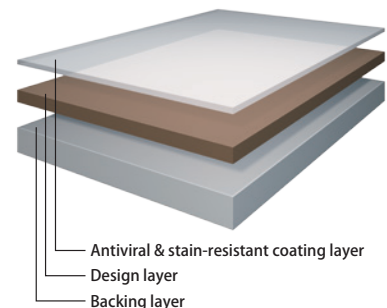

Antiviral & stain-resistant coating layer
Design layer
Backing layer

■ Specification

General name	Antiviral&Low-maintenance vinyl floor sheet(JIS A 5705)
Dimensions	2.0mm (thickness) × 1,820mm (width) × 9m (length)
Number of colors	10 colors
Packaging	9m/roll
Weight	3.3kg/m ² , 54kg/roll



JIS A 5705
QA0307072



Color variations

10colors

Oak



PRM-1805



PRM-1801



PRM-1802



PRM-1807



PRM-1808



Walnut



PRM-1837



PRM-1834



PRM-1833

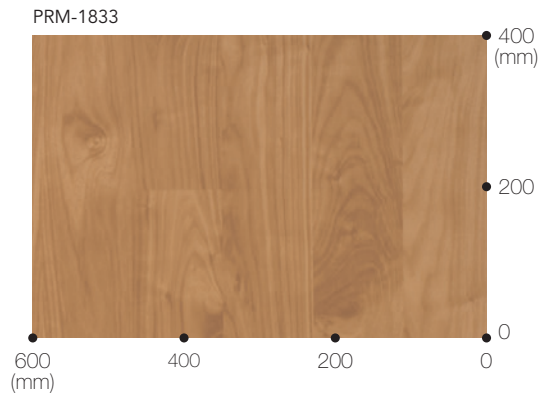

Cherry



PRM-1851



PRM-1852



Antiviral activity

In general terms, when a virus is inactivated, it disrupts its original growth cycle.

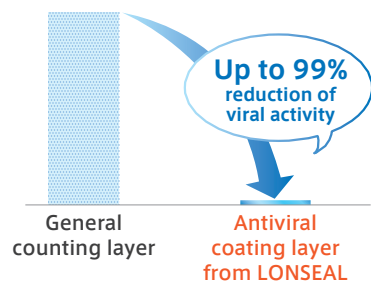
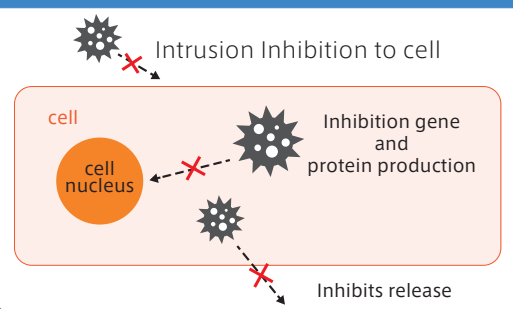

LONSEAL flooring has the uniform layer, so antiviral properties are effective in the long run.

LONPROTECT INLAID

ANTIVIRAL & HIGHLY DURABLE



PRB-2102

■ Features

Highly durable antiviral vinyl floor sheet with a contrasting inlaid pattern.

- No need to apply the floor polish on the surface.
- It reduces viral activity of enveloped viruses and non-enveloped viruses by up to 99%.
- It has excellent chemical-resistant such as acid and alkaline.
- It reduces leg fatigue by flexible shock absorbing surface.
- Extremely durable performance is suitable for high-traffic areas.

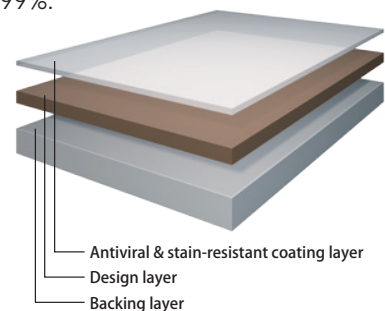

■ Specification

General name	Antiviral&Low-maintenance vinyl floor sheet(JIS A 5705)
Dimensions	2.0mm (thickness) × 1,820mm (width) × 9m (length)
Number of colors	15 colors
Packaging	9m/roll
Weight	3.3kg/m ² , 54kg/roll



JIS A 5705
QA0307072



■ Color variations

15colors



PRB-2101

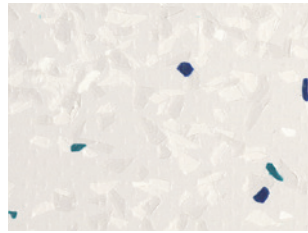

PRB-2110



PRB-2107

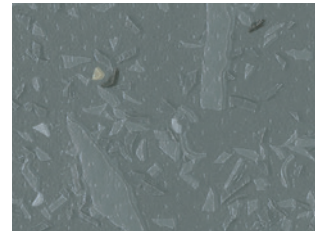

PRB-2108



PRB-2104

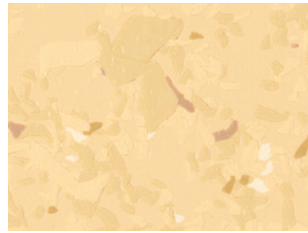

PRB-2105



PRB-2102

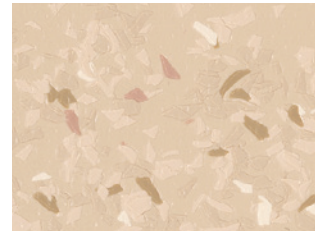

PRB-2103

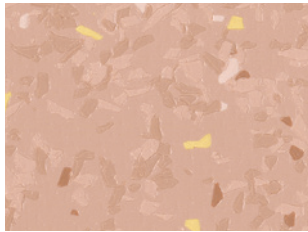

PRB-2114

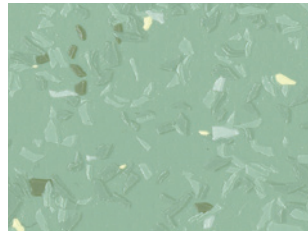

PRB-2111

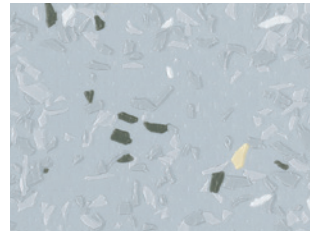

PRB-2109

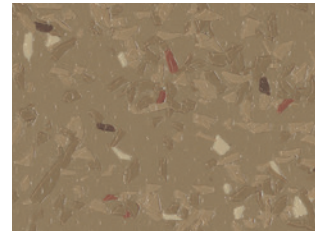

PRB-2106



PRB-2115

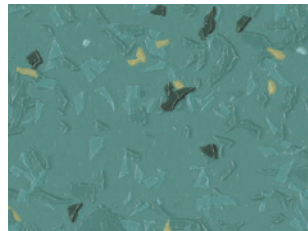

PRB-2112

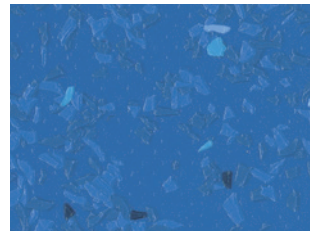

PRB-2113

So many latent viruses growing in our living environment

- Recent virus-related problems

Global spread of COVID-19

Spread of seasonal diseases

- Food poisoning problem of norovirus
- Influenza group infection

Problem of infection of highly virulent avian influenza to human

Make every portion in facilities antiviral by the LONPROTECT technology

Using the LONPROTECT technology to various things spreads antiviral effect to walls and floors among other places where many people gather in schools, hospitals, and such.

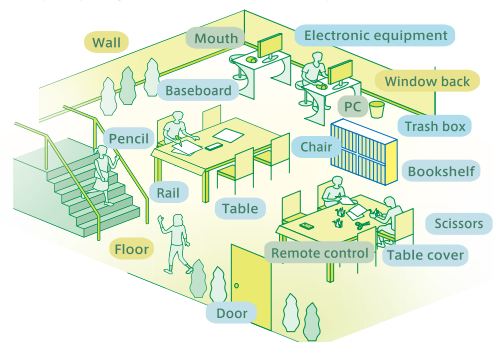

SANITALEUM ARPHA

ANTIVIRAL & HIGHLY DURABLE



SLA-8001 · SLA-8003

■ Features

Highly durable antiviral vinyl floor sheet with much color variations.

- It offers super stain-resistant.
- No need to apply the floor polish on the surface.
- It reduces viral activity of enveloped viruses and non-enveloped viruses by up to 99%.
- It has excellent chemical-resistant such as acid and alkaline.
- It reduces leg fatigue by flexible shock absorbing surface.
- Extremely durable performance is suitable for high-traffic areas.

■ Specification

General name	Antiviral&Low-maintenance vinyl floor sheet(JIS A 5705)
Dimensions	2.0mm (thickness) × 1,820mm (width) × 9m (length)
Number of colors	24 colors
Packaging	9m/roll
Weight	3.1kg/m ² , 51kg/roll

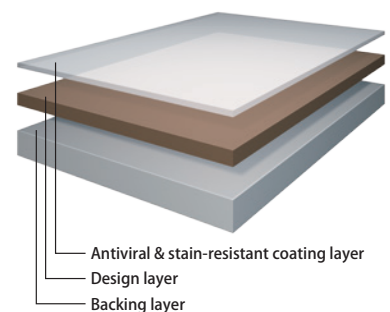

■ Color variations

24colors

Abstract pattern



SLA-8004



SLA-8001



SLA-8011



SLA-8012



SLA-8005



SLA-8002



SLA-8009



SLA-8010



SLA-8006

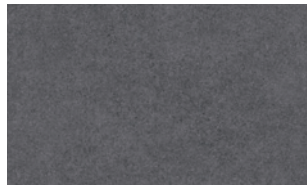

SLA-8003



SLA-8014

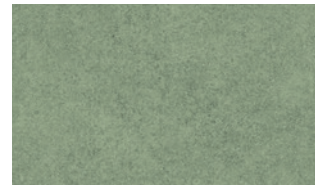

SLA-8015



SLA-8007

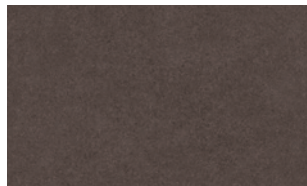

SLA-8008



SLA-8013

Wood grain pattern



SLA-1801



SLA-1802



SLA-1836



SLA-1832

Fabric pattern



SLA-2212

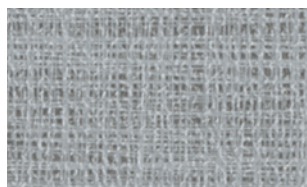

SLA-2202



SLA-2206



SLA-2203

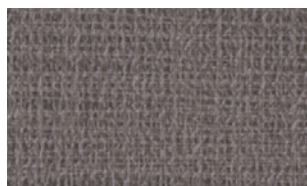

SLA-2207

LONFORM TEXCLOUD CT ANTIVIRAL



■ Features

Antiviral vinyl floor sheet with cushioned layer that has excellent shock absorption and flexible.

- It reduces injury when you fall and damage when accidentally dropping an object.
- No need to apply the floor polish on the surface.
- It reduces viral activity of enveloped viruses and non-enveloped viruses by up to 99%.
- It has excellent chemical-resistant such as acid and alkaline.
- Extremely durable performance is suitable for high-traffic areas.

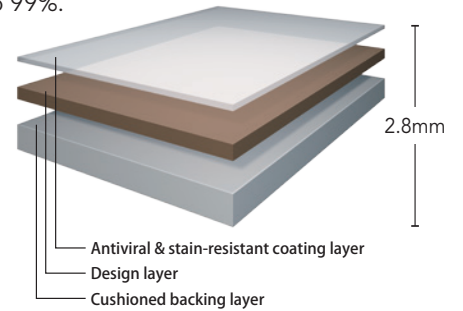

■ Specification

General name	Antiviral&Low-maintenance vinyl floor sheet with cushioned layer (JIS A 5705)
Dimensions	2.8mm (thickness) × 1,820mm (width) × 9m (length)
Number of colors	10 colors
Packaging	9m/roll
Weight	3.2kg/m ² , 52kg/roll

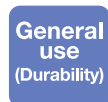

■ Color variations

10colors

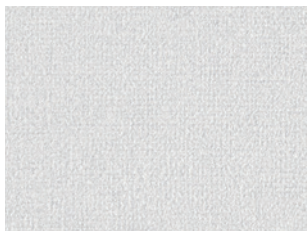

FCC-7001

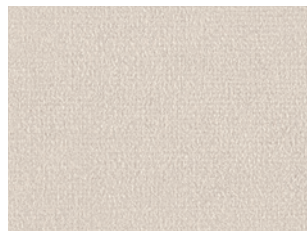

FCC-7004



FCC-7007

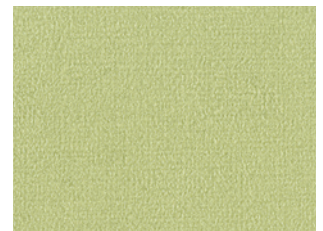

FCC-7009



FCC-7003



FCC-7005



FCC-7008



FCC-7010



FCC-7002



FCC-7006

LONFORM OPSECT **ANTIVIRAL**



■ Features

Antiviral vinyl floor sheet with cushioned layer that has excellent shock absorption and flexible.

- It reduces injury when you fall and damage when accidentally dropping an object.
- No need to apply the floor polish on the surface.
- It reduces viral activity of enveloped viruses and non-enveloped viruses by up to 99%.
- It has excellent chemical-resistant such as acid and alkaline.
- Extremely durable performance is suitable for high-traffic areas.

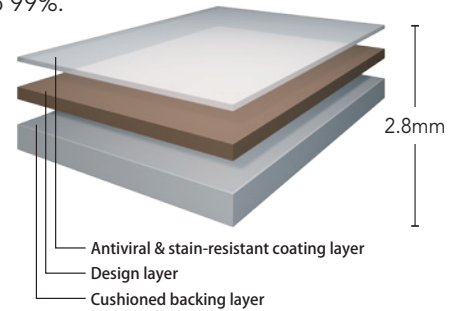

■ Specification

General name	Antiviral&Low-maintenance vinyl floor sheet with cushioned layer (JIS A 5705)
Dimensions	2.8mm (thickness) × 1,820mm (width) × 9m (length)
Number of colors	5 colors
Packaging	9m/roll
Weight	3.2kg/m ² , 52kg/roll

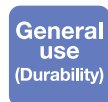

■ Color variations

5colors

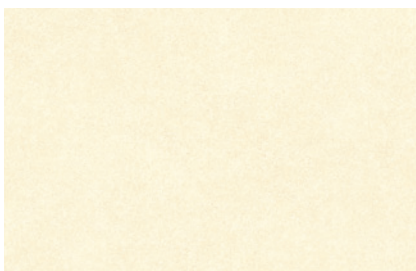

FPC-8004



FPC-8005



FPC-8007



FPC-8001



FPC-8002

LONFOAM MOKU CT ANTIVIRAL



FKC-1837

■ Features

Antiviral vinyl floor sheet with cushioned layer that has excellent shock absorption and flexible.

- It reduces injury when you fall and damage when accidentally dropping an object.
- No need to apply the floor polish on the surface.
- It reduces viral activity of enveloped viruses and non-enveloped viruses by up to 99%.
- It has excellent chemical-resistant such as acid and alkaline.
- Extremely durable performance is suitable for high-traffic areas.

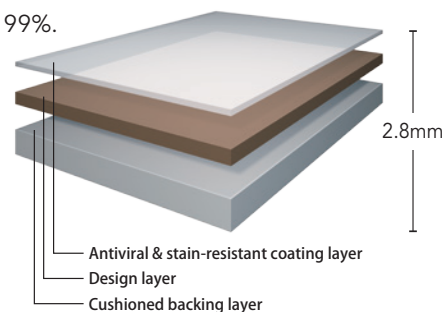

■ Specification

General name	Antiviral&Low-maintenance vinyl floor sheet with cushioned layer (JIS A 5705)
Dimensions	2.8mm (thickness) × 1,820mm (width) × 9m (length)
Number of colors	14 colors
Packaging	9m/roll
Weight	2.9kg/m ² , 48kg/roll



■ Color variations

14colors

Oak



FKC-1805

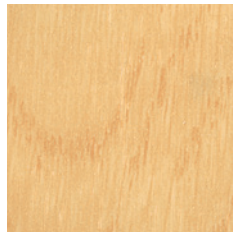

FKC-1801

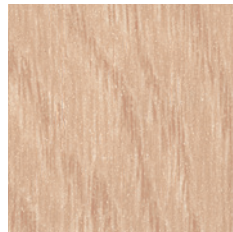

FKC-1806

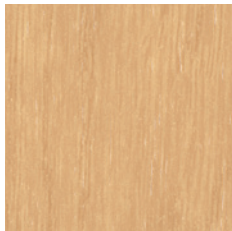

FKC-1802

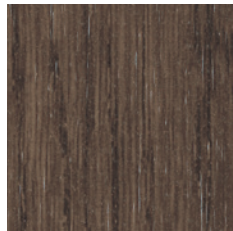

FKC-1808

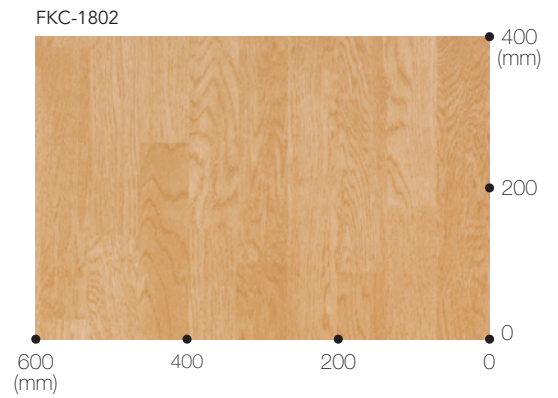

Walnut



FKC-1838



FKC-1837



FKC-1836

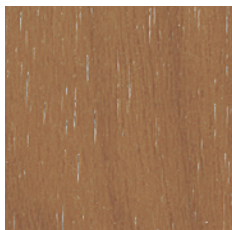

FKC-1833



FKC-1832



FKC-1831

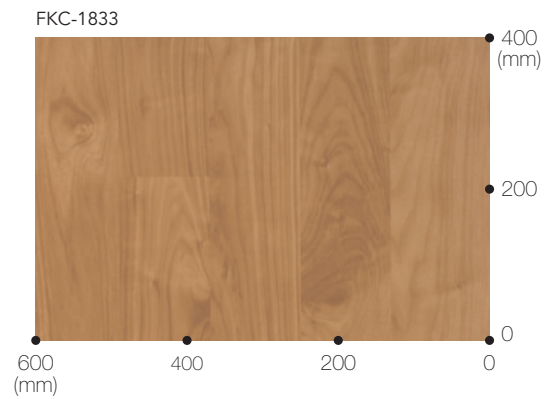

Cherry



FKC-1851



FKC-1852

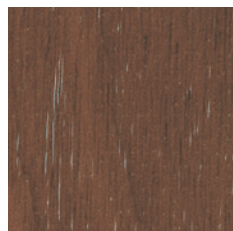

FKC-1854



WELLEUM CT ANTIVIRAL



WLC-1837

■ Features

Antiviral vinyl floor sheet with cushioned layer that has excellent shock absorption and flexible.

- It reduces injury when you fall and damage when accidentally dropping an object.
- No need to apply the floor polish on the surface.
- It reduces viral activity of enveloped viruses and non-enveloped viruses by up to 99%.
- It has excellent chemical-resistant such as acid and alkaline.
- Extremely durable performance is suitable for high-traffic areas.

Shock absorption



■ Specification

General name	Antiviral&Low-maintenance vinyl floor sheet with cushioned layer (JIS A 5705)
Dimensions	4.5mm(thickness)×1,820mm(width)×9m (length)
Number of colors	11 colors
Packaging	9m/roll
Weight	3.5kg/m ² , 57kg/roll

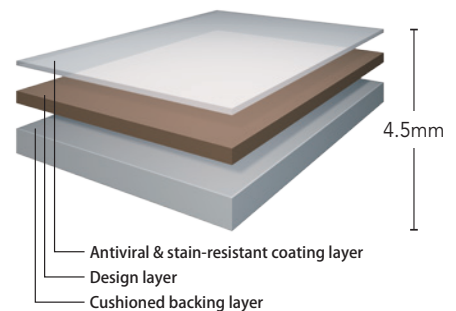

■ Color variations

11colors

Walnut



WLC-1837



WLC-1832



WLC-1836

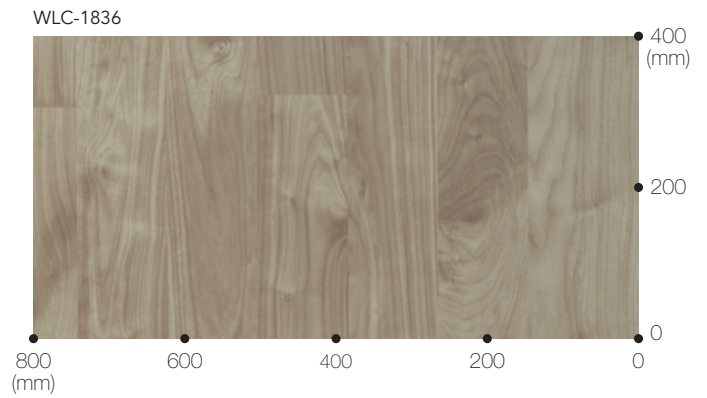

Natural oak

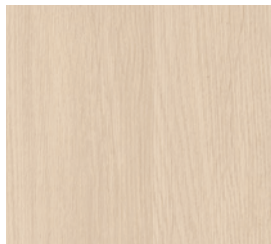

WLC-1811

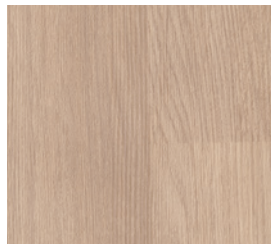

WLC-1813

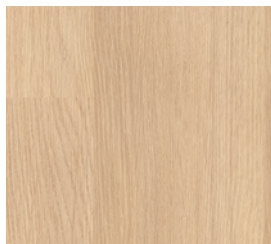

WLC-1812

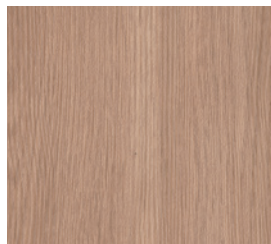

WLC-1814



Fabric pattern



WLC-7001



WLC-7007

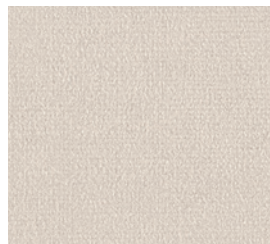

WLC-7004



WLC-7005

LONSAFE SHEET

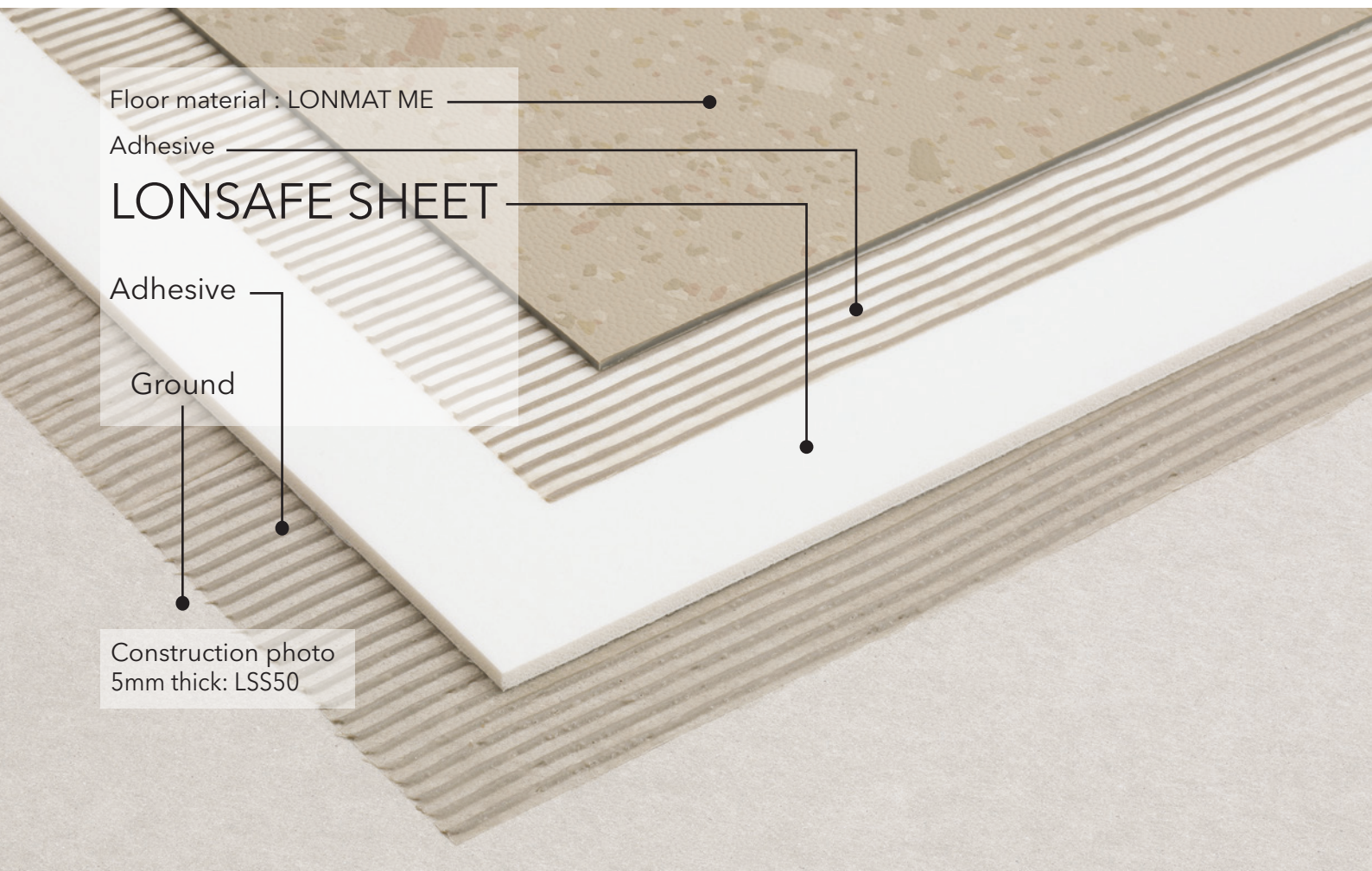

■ Features

The underlayment that is applied to all LONSEAL flooring.

- It is used for improving the shock absorbing performance and sound absorbing performance of the floor.
- Recommended for hospitals, nursing homes and fitness gyms ,etc where safety is particularly necessary.

■ Specification

General name	Underlay sheet
Dimensions	3.0mm (thickness) × 1,800mm (width) × 18m (length) 5.0mm (thickness) × 1,800mm (width) × 18m (length)
Number of colors	1 colors
Packaging	18m/roll
Weight	(3.0 mm) 1.1kg/m ² , 36kg/roll (5.0 mm) 1.6kg/m ² , 52kg/roll



■ Color variations 1color

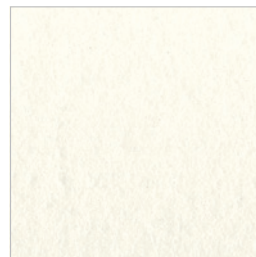

LSS30 (3.0mm thickness)
LSS50 (5.0mm thickness)

LONLAID AS



AS-106

■ Features

Highly durable slip-resistant vinyl sheet for indoor use.

- It has slip-resistant even if its surface gets wet.
- The thick surface layer is extremely durable performance and is suitable for high-traffic areas.
- It has heat-resistant to boiling water and hot oil.
- Its surface is smooth, so it offers preventing dirt build-up and is easy to clean.

●Cross-section

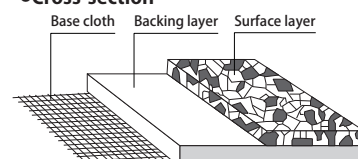

■ Specification

General name	Slip-resistant vinyl floor sheet(JIS A 5705)
Dimensions	2.5mm (thickness) × 1,820mm (width) × 9m (length)
Number of colors	6 colors
Packaging	9m/roll
Weight	4.0kg/m ² , 66kg/roll

■ Color variations

6colors

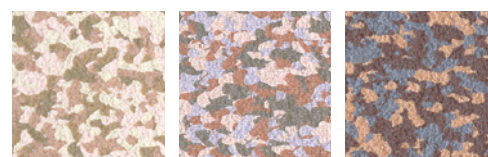

AS-106

AS-107

AS-103



AS-108

AS-101

AS-105



LONLAID AS COMFORT



■ Features

Slip-resistant vinyl sheet for indoor use.

- It has slip-resistant even if its surface gets wet.
- The thick surface layer is extremely durable performance and is suitable for high-traffic areas.
- It has heat-resistant to boiling water and hot oil.
- Its surface is smooth, so it offers preventing dirt build-up and is easy to clean.

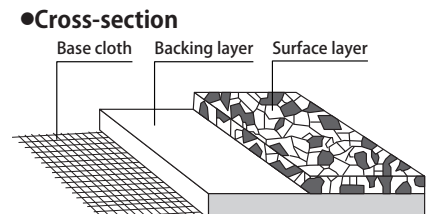

■ Specification

General name	Slip-resistant vinyl floor sheet(JIS A 5705)
Dimensions	2.0mm (thickness) × 1,820mm (width) × 9m (length)
Number of colors	8 colors
Packaging	9m/roll
Weight	3.1kg/m ² , 51kg/roll

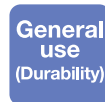

■ Color variations

8colors

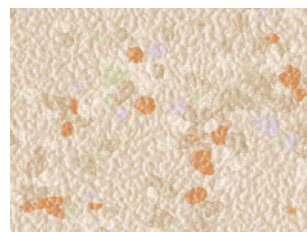
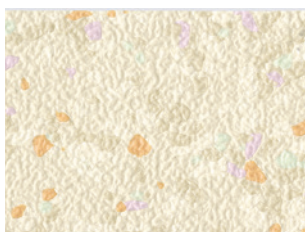
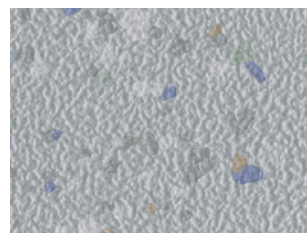

LONMAT ME DIAMOND



DM-164

■ Features

Slip-resistant vinyl sheet for indoor use.

- It has unique embossed shape that is slip-resistant.
- It reduces leg fatigue by flexible shock absorbing surface.

■ Specification

General name	Slip-resistant vinyl floor sheet(JIS A 5705)
Dimensions	2.8mm (thickness of convex part) × 1,820mm (width) × 9m (length)
Number of colors	3 colors
Packaging	9m/roll
Weight	2.7kg/m ² , 44kg/roll



●Cross-section

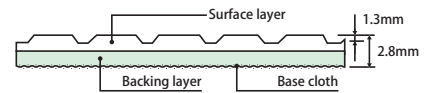

●Pattern dimensions

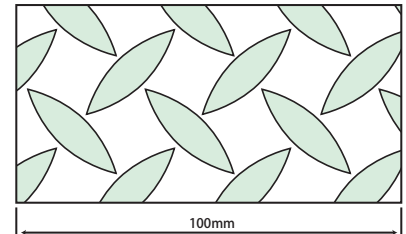

■ Color variations

3colors



DM-161

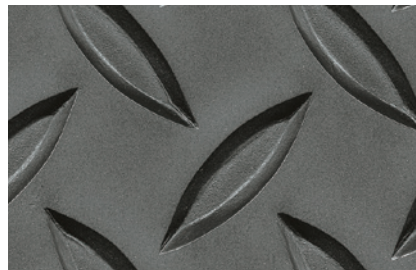

DM-164



DM-135

LONMAT ME TRICO



TO-03

■ Features

Slip-resistant vinyl sheet with a fiber pattern for outdoor use.

- It has excellent weather-resistant, so it is little color deterioration due to sunlight.
- It has unique embossed shape that is slip-resistant.
- It reduces leg fatigue by flexible shock absorbing surface.

●Cross-section

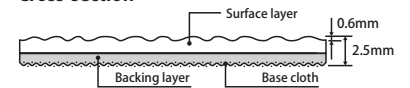

■ Specification

General name	Slip-resistant vinyl floor sheet(JIS A 5705)
Dimensions	2.5mm (thickness of convex part) × 1,350mm (width) × 9m (length) 2.5mm (thickness of convex part) × 1,820mm (width) × 9m (length)
Number of colors	3 colors
Packaging	9m/roll
Weight	3.4kg/m ² , 41kg/roll (1,350mm width) 55kg/roll (1,820mm width)

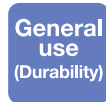

■ Color variations

3colors



TO-01



TO-02



TO-03

LONMAT ME ARMO STONE



AM-02

■ Features

Slip-resistant vinyl sheet with a stone grain pattern for outdoor use.

- It has excellent weather-resistant, so it is little color deterioration due to sunlight.
- It has unique embossed shape that is slip-resistant.
- It reduces leg fatigue by flexible shock absorbing surface.

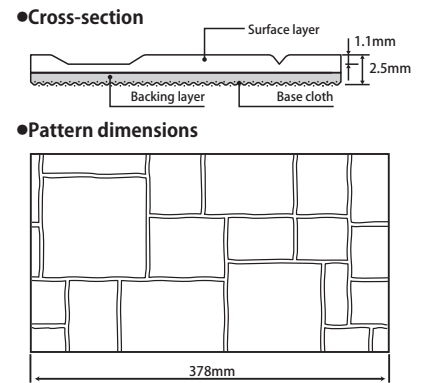

■ Specification

General name	Slip-resistant vinyl floor sheet(JIS A 5705)
Dimensions	2.5mm (thickness of convex part) × 1,350mm (width) × 9m (length) 2.5mm (thickness of convex part) × 1,820mm (width) × 9m (length)
Number of colors	3 colors
Packaging	9m/roll
Weight	3.3kg/m ² , 40kg/roll (1,350mm width) 54kg/roll (1,820mm width)



■ Color variations

3colors



AM-01



AM-02



AM-03

LONMAT ME RANDOM HERRING



HE-02

■ Features

Slip-resistant vinyl sheet with a geometric pattern for outdoor use.

- It has excellent weather-resistant, so it is little color deterioration due to sunlight.
- It has unique embossed shape that is slip-resistant.
- It reduces leg fatigue by flexible shock absorbing surface.

●Cross-section

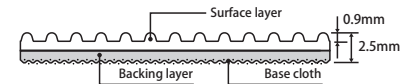

●Pattern dimensions

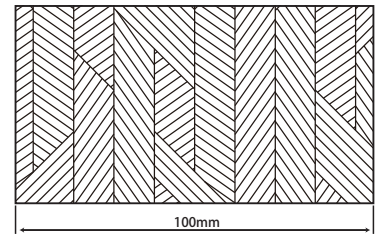

■ Specification

General name	Slip-resistant vinyl floor sheet(JIS A 5705)
Dimensions	2.5mm (thickness of convex part) × 1,350mm (width) × 9m (length) 2.5mm (thickness of convex part) × 1,820mm (width) × 9m (length)
Number of colors	2 colors
Packaging	9m/roll
Weight	3.3kg/m ² , 40kg/roll (1,350mm width) 54kg/roll (1,820mm width)

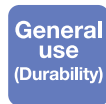

■ Color variations

2colors

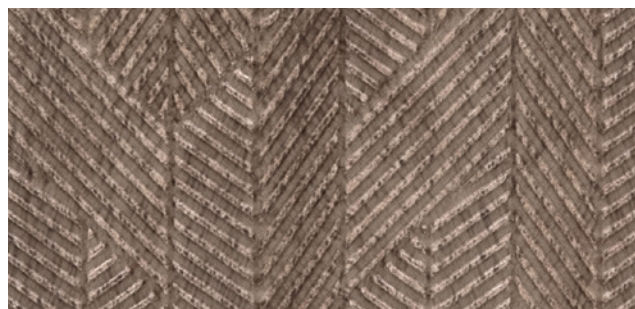
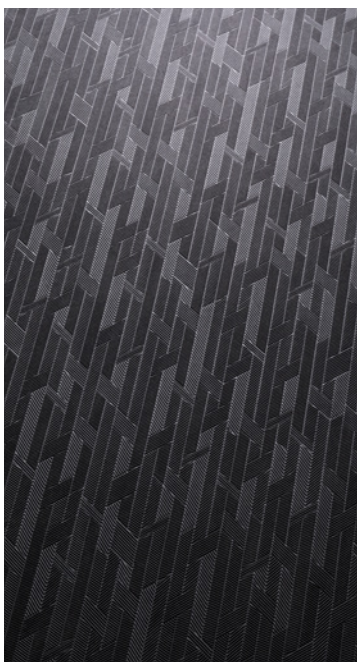

HE-01



HE-02

LONMAT ME JASPER



■ Features

Slip-resistant vinyl sheet for outdoor use.

- It has excellent weather-resistant, so it is little color deterioration due to sunlight.
- It has unique embossed shape that is slip-resistant.
- It reduces leg fatigue by flexible shock absorbing surface.

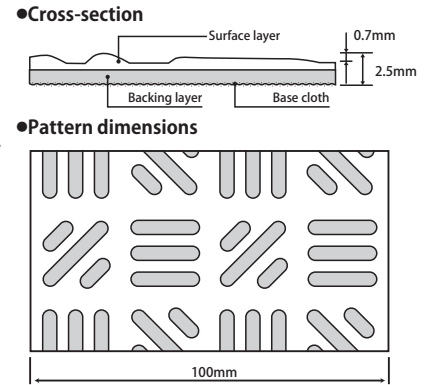

■ Specification

General name	Slip-resistant vinyl floor sheet(JIS A 5705)
Dimensions	2.5mm (thickness of convex part) × 1,350mm (width) × 9m (length) 2.5mm (thickness of convex part) × 1,820mm (width) × 9m (length)
Number of colors	7 colors
Packaging	9m/roll
Weight	3.0kg/m ² , 36kg/roll (1,350mm width) 49kg/roll (1,820mm width)



■ Color variations

7colors

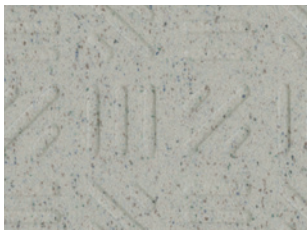

JP-11



JP-12



JP-13



JP-15



JP-27



JP-28



JP-220

LONMAT ME PASELAT

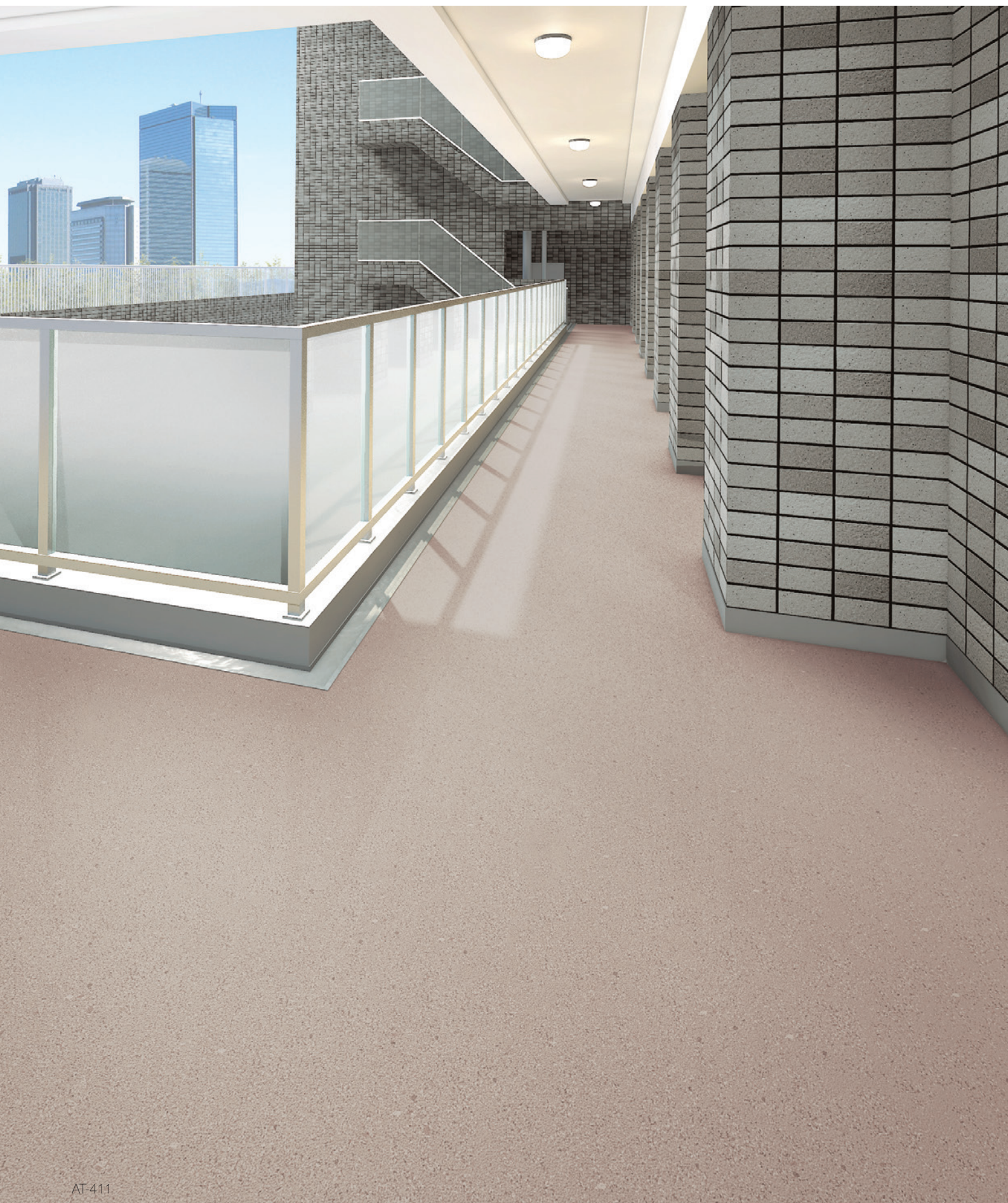

AT-411

■ Features

Slip-resistant vinyl sheet for outdoor use.

- It has excellent weather-resistant, so it is little color deterioration due to sunlight.
- It has slip-resistant even if its surface gets wet.
- Its surface is smooth, so it offers preventing dirt build-up and is easy to clean.

● Cross-section

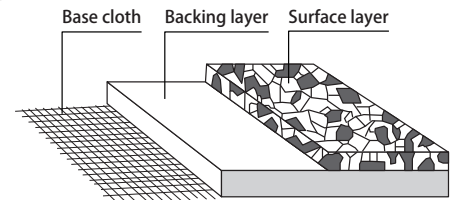

■ Specification

General name	Slip-resistant vinyl floor sheet(JIS A 5705)
Dimensions	2.5mm (thickness of convex part) × 1,350mm (width) × 9m (length) 2.5mm (thickness of convex part) × 1,820mm (width) × 9m (length)
Number of colors	9 colors
Packaging	9m/roll
Weight	3.7kg/m ² , 45kg/roll (1,350mm width) 61kg/roll (1,820mm width)

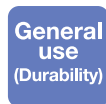

■ Color variations

9 colors

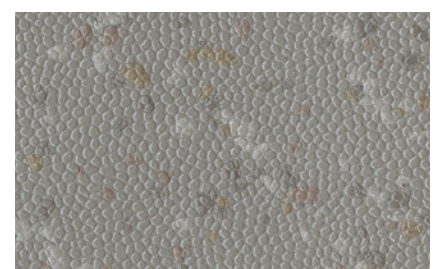
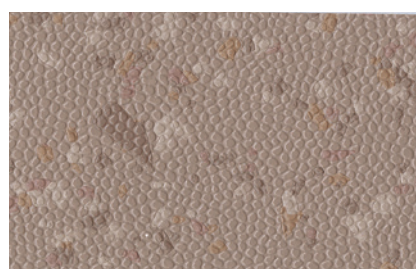
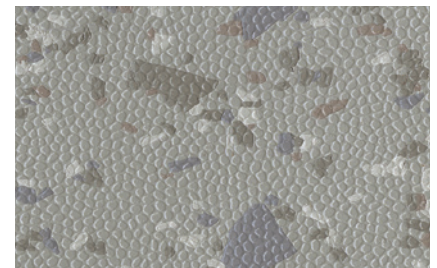
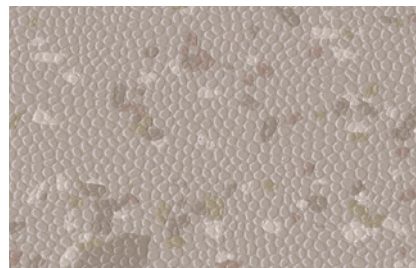
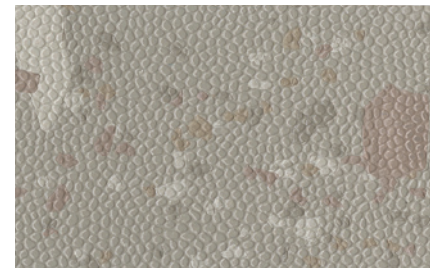

LONMAT ME ROZETA



RT-31

■ Features

Slip-resistant vinyl sheet for outdoor use.

- It has excellent weather-resistant, so it is little color deterioration due to sunlight.
- It has unique embossed shape that is slip-resistant.
- It reduces leg fatigue by flexible shock absorbing surface.

■ Specification

General name	Slip-resistant vinyl floor sheet(JIS A 5705)
Dimensions	2.5mm (thickness of convex part) × 1,350mm (width) × 9m (length) 2.5mm (thickness of convex part) × 1,820mm (width) × 9m (length)
Number of colors	4 colors
Packaging	9m/roll
Weight	3.1kg/m ² , 38kg/roll (1,350mm width) 51kg/roll (1,820mm width)



●Cross-section

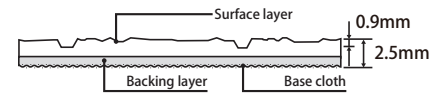

●Pattern dimensions

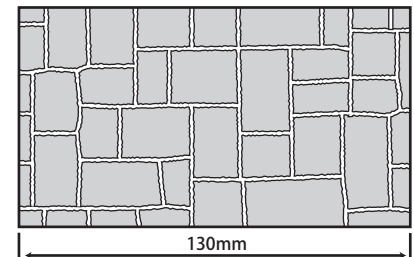

■ Color variations

4colors



RT-31



RT-30



RT-21



RT-32

LONMAT ME HOLZWOOD



HZ-02

■ Features

Slip-resistant vinyl sheet with a wood grain pattern for outdoor use.

- It has excellent weather-resistant, so it is little color deterioration due to sunlight.
- It has unique embossed shape that is slip-resistant.
- It reduces leg fatigue by flexible shock absorbing surface.

● Cross-section

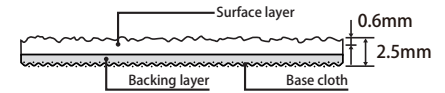

■ Specification

General name	Slip-resistant vinyl floor sheet(JIS A 5705)
Dimensions	2.5mm (thickness of convex part) × 1,350mm (width) × 9m (length) 2.5mm (thickness of convex part) × 1,820mm (width) × 9m (length)
Number of colors	3 colors
Packaging	9m/roll
Weight	3.4kg/m ² , 41kg/roll (1,350mm width) 56kg/roll (1,820mm width)

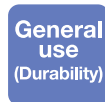

■ Color variations

3colors



HZ-01



HZ-02

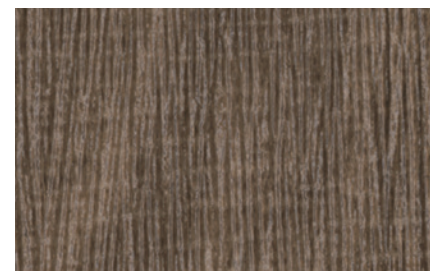

HZ-03

HZ-01

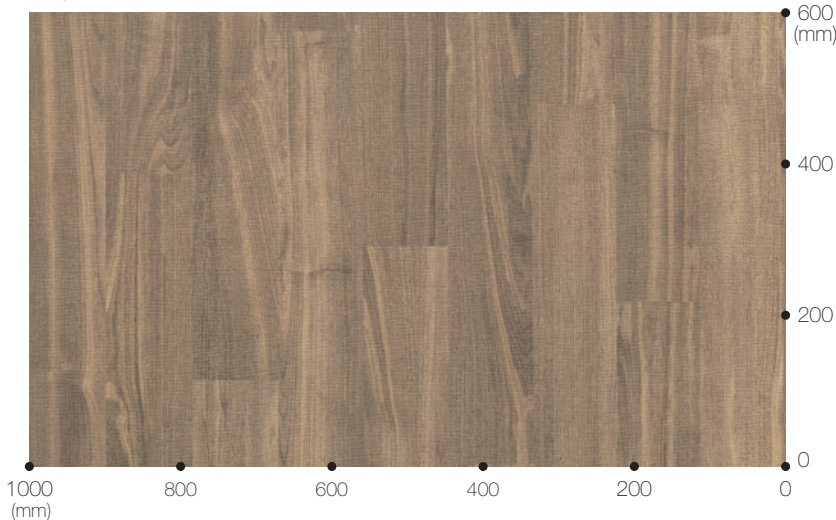

LONMAT ME TWILL II



TWL-403

■ Features

Slip-resistant vinyl sheet for outdoor use.

- It has excellent weather-resistant, so it is little color deterioration due to sunlight.
- It has unique embossed shape that is slip-resistant.
- It reduces leg fatigue by flexible shock absorbing surface.

● Cross-section

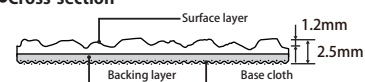

● Pattern dimensions

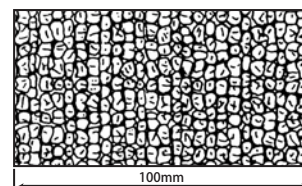

■ Specification

General name	Slip-resistant vinyl floor sheet(JIS A 5705)
Dimensions	2.5mm (thickness of convex part) × 1,350mm (width) × 9m (length) 2.5mm (thickness of convex part) × 1,820mm (width) × 9m (length)
Number of colors	5 colors
Packaging	9m/roll
Weight	3.3kg/m ² , 40kg/roll (1,350mm width) 54kg/roll (1,820mm width)

■ Color variations 5 colors



TWL-401 TWL-402 TWL-403



TWL-404 TWL-405



LONMAT ME SCORE



SCE-205

■ Features

Slip-resistant vinyl sheet for outdoor use.

- It has excellent weather-resistant, so it is little color deterioration due to sunlight.
- It has unique embossed shape that is slip-resistant.
- It reduces leg fatigue by flexible shock absorbing surface.

■ Specification

General name	Slip-resistant vinyl floor sheet(JIS A 5705)
Dimensions	2.5mm (thickness of convex part) × 1,350mm (width) × 9m (length) 2.5mm (thickness of convex part) × 1,820mm (width) × 9m (length)
Number of colors	5 colors
Packaging	9m/roll
Weight	3.1kg/m ² , 38kg/roll (1,350mm width) 51kg/roll (1,820mm width)

●Cross-section

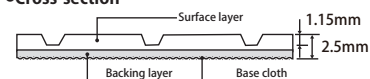

●Pattern dimensions

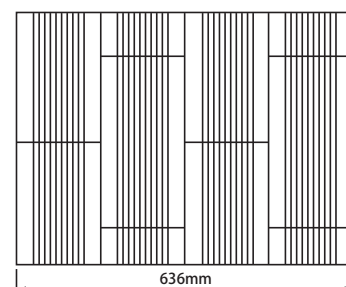

■ Color variations 5 colors



SCE-202

SCE-203

SCE-201



SCE-204

SCE-205

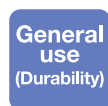

LONMAT ME RESTARIA HS

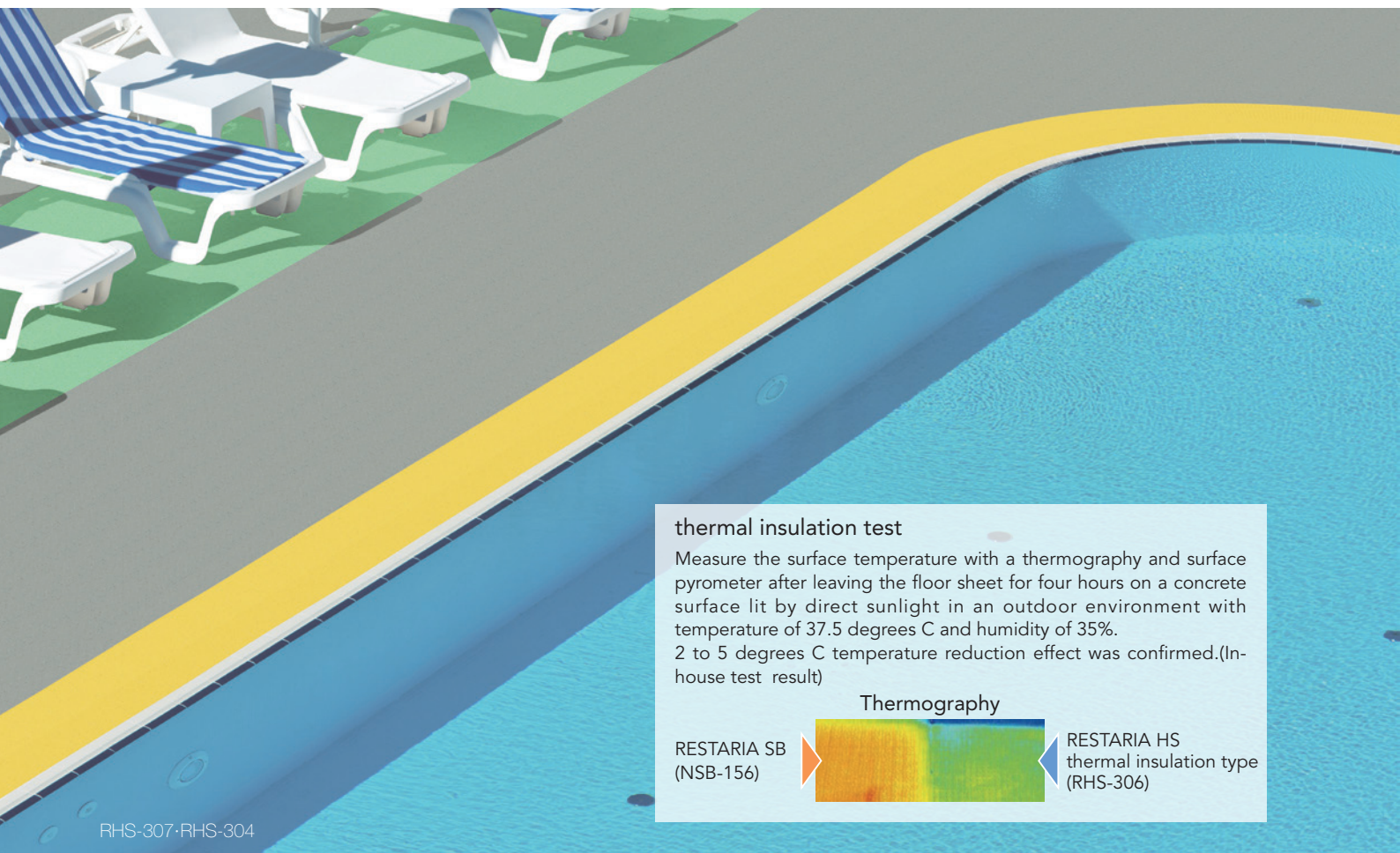

thermal insulation test

Measure the surface temperature with a thermography and surface pyrometer after leaving the floor sheet for four hours on a concrete surface lit by direct sunlight in an outdoor environment with temperature of 37.5 degrees C and humidity of 35%. 2 to 5 degrees C temperature reduction effect was confirmed.(In-house test result)

Thermography

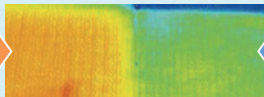
RESTARIA SB (NSB-156)  RESTARIA HS thermal insulation type (RHS-306)

RHS-307·RHS-304

■ Features

Slip-resistant vinyl sheet for the poolside.

- It prevents temperature rise of the sheet due to direct sunlight.
- It has excellent weather-resistant, so it is little color deterioration due to sunlight.
- It has unique embossed shape that is slip-resistant.
- In addition, it is suitable for use in rooftops of apartments and for porches, balconies, and connecting corridors without a roof.
- It has excellent chemical-resistant such as pool disinfectants.

■ Specification

General name	Slip-resistant vinyl floor sheet for the poolside(JIS A 5705)
Dimensions	3.0mm (thickness of convex part) × 1,820mm (width) × 9m (length)
Number of colors	7 colors
Packaging	9m/roll
Weight	4.1kg/m ² , 67kg/roll

●Cross-section

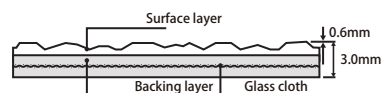

●Pattern dimensions

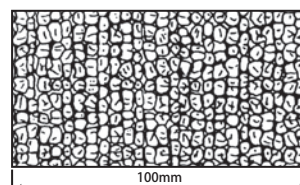

■ Color variations 7colors









LONMAT ME RESTARIA SB



NSB-156-NSB-158

■ Features

Slip-resistant vinyl sheet for the poolside.

- It has excellent weather-resistant, so it is little color deterioration due to sunlight.
- It has unique embossed shape that is slip-resistant.
- In addition, it is suitable for use in rooftops of apartments and for porches, balconies, and connecting corridors without a roof.
- It has excellent chemical-resistant such as pool disinfectants.

● Cross-section

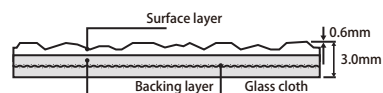

● Pattern dimensions

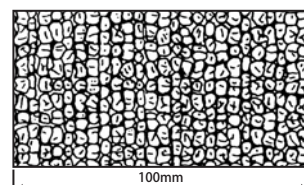

■ Specification

General name	Slip-resistant vinyl floor sheet for the poolside(JIS A 5705)
Dimensions	3.0mm (thickness of convex part) × 1,820mm (width) × 9m (length)
Number of colors	9 colors
Packaging	9m/roll
Weight	4.2kg/m ² , 69kg/roll



■ Color variations

9 colors



NSB-151



NSB-152



NSB-153

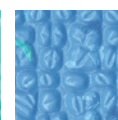

NSB-154



NSB-157



NSB-158



NSB-159

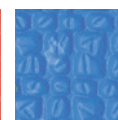

NSB-155



NSB-156

LONSTEP ME FZK EMBOSS TYPE –TRICO TYPE–



FZK-01

■ Features

Slip-resistant vinyl sheet for stairs and is outdoor use.

- It realized high visibility by the caution line of the nosing.
- The nosing, tread sheet, and riser sheet are integrated.
- It has excellent weather-resistant, so it is little color deterioration due to sunlight.
- It has unique embossed shape that is slip-resistant.

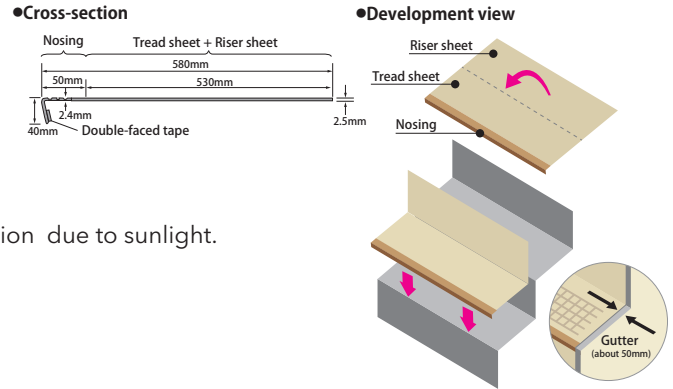

■ Specification

General name	Slip-resistant vinyl floor sheet for stairs
Dimensions	2.4mm (thickness of nosing convex) × 900mm (width) × 580mm (depth) 2.4mm (thickness of nosing convex) × 1,200mm (width) × 580mm (depth)
Number of colors	Nosing : 2 colors Tread sheet : 3 colors
Nosing R	4R
Packaging	7 sheets/case
Weight	900mm (width) type : 1.9kg/sheet, 13.6kg/case (7 sheets) 1,200mm (width) type : 2.5kg/sheet, 18kg/case (7 sheets)



■ Color variations

3colors

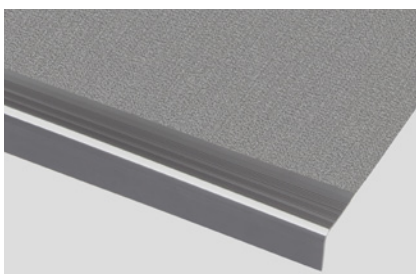

FZK-01

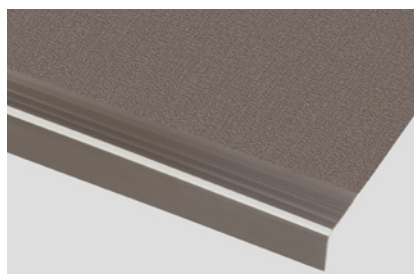

FZK-02

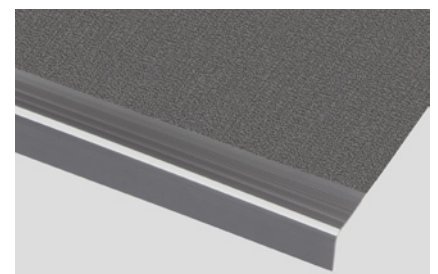

FZK-03

LONSTEP ME FZK EMOSS TYPE –JASPER TYPE–



FZK-27

■ Features

Slip-resistant vinyl sheet for stairs and is outdoor use.

- It realized high visibility by the caution line of the nosing.
- The nosing, tread sheet, and riser sheet are integrated.
- It has excellent weather-resistant, so it is little color deterioration due to sunlight.
- It has unique embossed shape that is slip-resistant.

●Cross-section

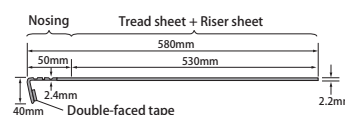

●Development view

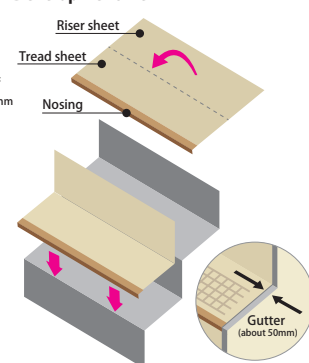

■ Specification

General name	Slip-resistant vinyl floor sheet for stairs
Dimensions	2.4mm (thickness of nosing convex) × 900mm (width) × 580mm (depth) 2.4mm (thickness of nosing convex) × 1,200mm (width) × 580mm (depth)
Number of colors	Nosing : 2 colors Tread sheet : 7 colors
Nosing R	4R
Packaging	7 sheets/case
Weight	900mm (width) type : 2.0kg/sheet, 14.0kg/case (7 sheets) 1,200mm (width) type : 2.6kg/sheet, 18.2kg/case (7 sheets)

■ Color variations 7colors

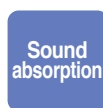
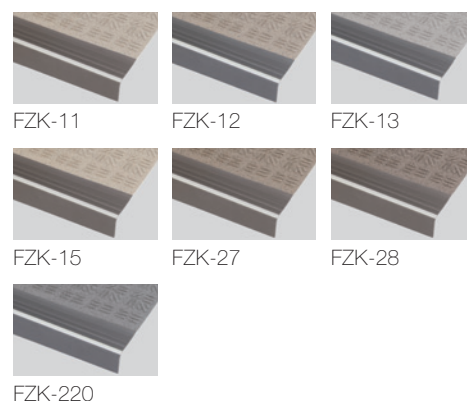

LONSTEP ME FZK FLAT TYPE –PASELAT TYPE–



FZK-412

■ Features

Slip-resistant vinyl sheet for stairs and is outdoor use.

- It realized high visibility by the caution line of the nosing.
- The nosing, tread sheet, and riser sheet are integrated.
- It has excellent weather-resistant, so it is little color deterioration due to sunlight.
- It has slip-resistant even if its surface gets wet.
- Its surface is smooth, so it offers preventing dirt build-up and is easy to clean.

●Cross-section

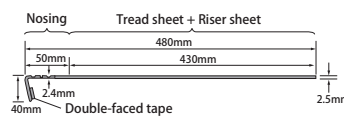

●Nosing

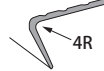

●Development view

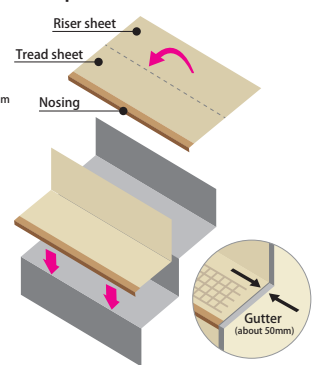

■ Specification

General name	Slip-resistant vinyl floor sheet for stairs
Dimensions	2.4mm (thickness of nosing convex) × 900mm (width) × 480mm (depth) 2.4mm (thickness of nosing convex) × 1,200mm (width) × 480mm (depth)
Number of colors	Nosing : 2 colors Tread sheet : 6 colors
Nosing R	4R
Packaging	7 sheets/case
Weight	900mm (width) type : 1.6kg/sheet, 11.2kg/case (7 sheets) 1,200mm (width) type : 2.1kg/sheet, 14.7kg/case (7 sheets)

■ Color variations 6 colors

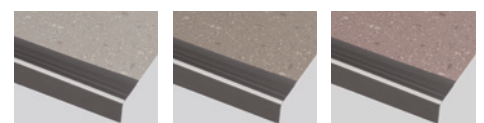

FZK-401

FZK-402

FZK-403

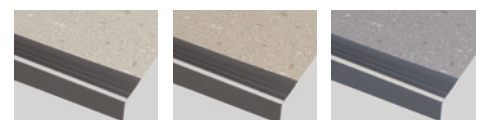

FZK-407

FZK-410

FZK-412

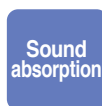

LONSTAC R



LSR-902 · LSR-134

■ Features

Antistatic&Antibacterial vinyl floor sheet.

- It has performance that absorbs static electricity in the long run.
- It can be integrated the floor by dedicated welding rod, so it prevents dust build-up and is easy to clean.
- Easy to process, so it fits easily into the installation location.
- It complies with NFPA codes and standards(*1).

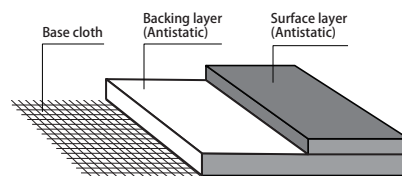

■ Specification

General name	Antistatic&Antibacterial vinyl floor sheet FS (JIS A 5705)
Dimensions	2.0mm (thickness) × 1,820mm (width) × 9m (length)
Number of colors	4 colors
Packaging	9m/roll
Weight	3.0kg/m ² , 50kg/roll
Conductivity	10 ⁸ ~10 ⁹ [Ω]



■ Color variations

4 colors

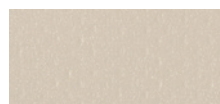

LSR-134

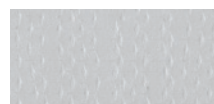

LSR-902

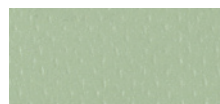

LSR-138



LSR-512

*1 They originated in Massachusetts and are more than 300 consensus codes and standards that are intended to minimize the possibility and effects of fire and other risks. It pass RoHS compliant(*2).

*2 It originated in the European Union and restricts the use of six hazardous materials found in electrical and electronic products.

FA STAC R



FAR-902

■ Features

Antistatic&Antibacterial&Anti-heavy traffic vinyl floor sheet

- It has performance that absorbs static electricity in the long run.
- It can be integrated the floor by dedicated welding rod, so it prevents dust build-up and is easy to clean.
- Easy to process, so it fits easily into the installation location.
- It complies with NFPA codes and standards(*1).

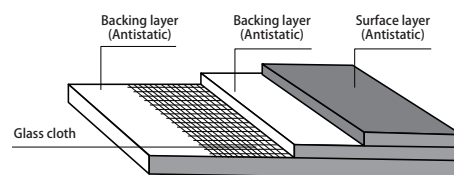

■ Specification

General name	Antistatic&Antibacterial vinyl floor sheet FS (JIS A 5705)
Dimensions	2.0mm (thickness) × 1,820mm (width) × 9m (length)
Number of colors	4 colors
Packaging	9m/roll
Weight	3.1kg/m ² , 51kg/roll
Conductivity	10 ³ ~10 ⁹ [Ω]

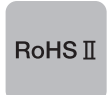

■ Color variations 4 colors



FAR-134

FAR-902



FAR-138

FAR-512

*1 They originated in Massachusetts and are more than 300 consensus codes and standards that are intended to minimize the possibility and effects of fire and other risks. It pass RoHS compliant(*2).

*2 It originated in the European Union and restricts the use of six hazardous materials found in electrical and electronic products.

CD LEUM R



CDR-902

■ Features

Conductive&Antibacterial vinyl floor sheet

- It has performance that absorbs static electricity.
- It can be integrated the floor by dedicated welding rod, so it prevents dust build-up and is easy to clean.
- Easy to process, so it fits easily into the installation location.
- It complies with NFPA codes and standards(*1).

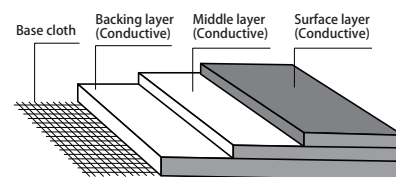

■ Specification

General name	Conductive&Antibacterial vinyl floor sheet FS (JIS A 5705)
Dimensions	2.0mm (thickness) × 1,820mm (width) × 9m (length)
Number of colors	5 colors
Packaging	9m/roll
Weight	3.1kg/m ² , 51kg/roll
Conductivity	10 ⁶ ~10 ⁷ 【Ω】

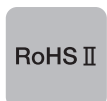

■ Color variations 5colors



CDR-134 CDR-902 CDR-138



CDR-512 CDR-602

*1 They originated in Massachusetts and are more than 300 consensus codes and standards that are intended to minimize the possibility and effects of fire and other risks. It pass RoHS compliant(*2).

*2 It originated in the European Union and restricts the use of six hazardous materials found in electrical and electronic products.

TCD R



TCDR-602

■ Features

Conductive&Antibacterial&Anti-heavy traffic vinyl floor sheet

- It has performance that absorbs static electricity.
- It has extremely durable performance to rolling loads.
- It can be integrated the floor by dedicated welding rod, so it prevents dust build-up and is easy to clean.
- Easy to process, so it fits easily into the installation location.
- It complies with NFPA codes and standards(*1).

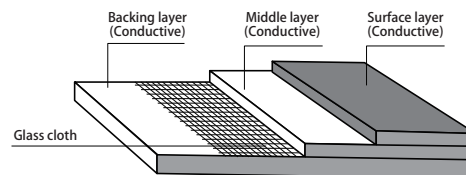

■ Specification

General name	Conductive&Antibacterial&Anti-heavy traffic vinyl floor sheet(JIS A 5705)
Dimensions	2.0mm (thickness) × 1,820mm (width) × 9m (length)
Number of colors	5 colors
Packaging	9m/roll
Weight	3.1kg/m ² , 50kg/roll
Conductivity	10 ⁶ ~10 ⁷ [Ω]



■ Color variations 5colors



*1 They originated in Massachusetts and are more than 300 consensus codes and standards that are intended to minimize the possibility and effects of fire and other risks. It pass RoHS compliant(*2).

*2 It originated in the European Union and restricts the use of six hazardous materials found in electrical and electronic products.

ANTI CHEMICAL SUPERLEUM



■ Features

Chemical-resistant&Antistatic&Antibacterial vinyl floor sheet

- It has chemical-resistant such as industrial chemical, acid and alkaline.
- It can be integrated the floor by dedicated welding rod or epoxy joint sealer, so it prevents dust build-up and is easy to clean.
- Easy to process, so it fits easily into the installation location.
- It complies with NFPA codes and standards(*).

*They originated in Massachusetts and are more than 300 consensus codes and standards that are intended to minimize the possibility and effects of fire and other risks.

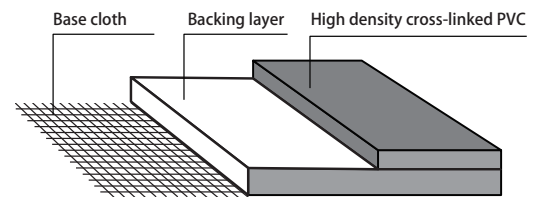

■ Specification

General name	Chemical-resistant&Antistatic&Antibacterial vinyl floor sheet(JIS A 5705)
Dimensions	2.0mm (thickness) × 1,820mm (width) × 9m (length)
Number of colors	7 colors
Packaging	9m/roll
Weight	2.9kg/m ² , 48kg/roll



■ Color variations

7colors



TS-3

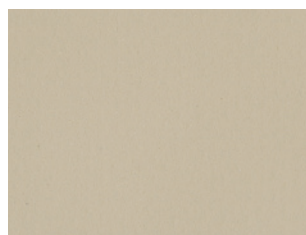

TS-1

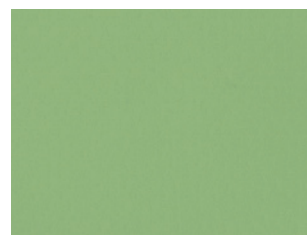

TS-5



TS-6

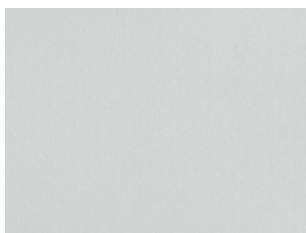

TS-7



TS-4

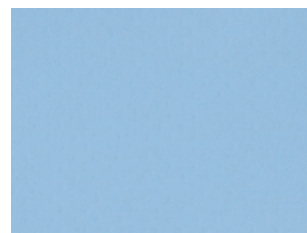

TS-9

LONTILE OA MERAVYWOOD CT



OAC-813

■ Features

Antistatic vinyl loose lay tile with a wood grain pattern

- No need to apply the floor polish on the surface.
- It has performance that absorbs static electricity.
- It has excellent chemical-resistant such as acid and alkaline.

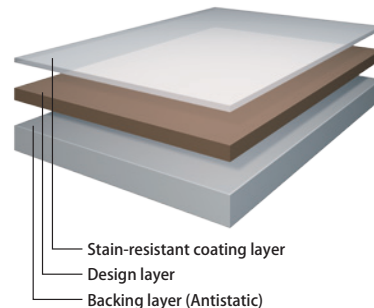

■ Specification

General name	Antistatic&Low-maintenance vinyl loose lay tile
Dimensions	5.0mm (thickness) size : 166.7mm×1,000mm
Number of colors	7 colors
Packaging	12 pcs/case
Weight	8.9kg/m ² , 18kg/case



■ Color variations

7colors

Oak

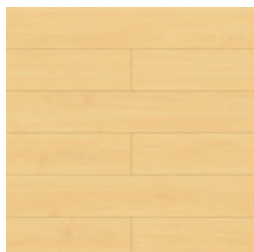

OAC-811

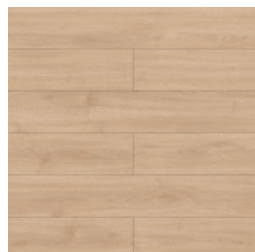

OAC-812



OAC-813



OAC-814



OAC-813

Antique Oak



OAC-821



OAC-822



OAC-823



OAC-822

LONTILE OA IDEASTONE CT



OAC-912

■ Features

Antistatic vinyl loose lay tile with a stone grain pattern

- No need to apply the floor polish on the surface.
- It has performance that absorbs static electricity.
- It has excellent chemical-resistant such as acid and alkaline.

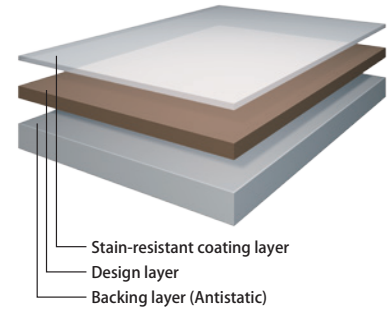

■ Specification

General name	Antistatic&Low-maintenance vinyl loose lay tile
Dimensions	5.0mm (thickness) size : 500mm×500mm
Number of colors	3 colors
Packaging	10 pcs/case
Weight	8.4kg/m ² , 21kg/case

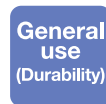

■ Color variations

3 colors



OAC-911

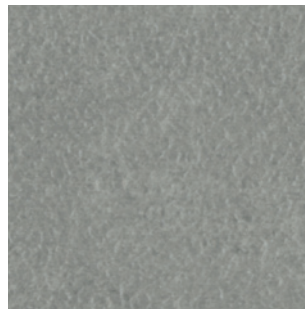

OAC-912

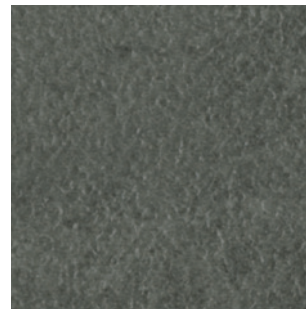

OAC-913

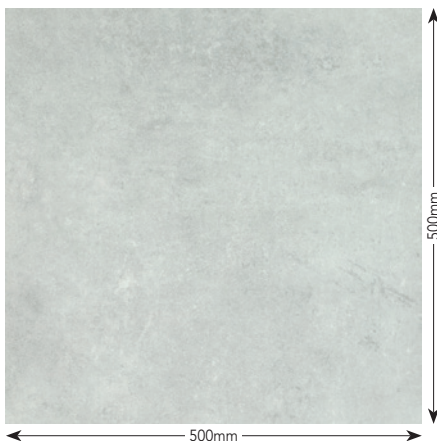

OAC-911

PERHOLON TILE CARPET LL-1100



LL-1102L

■ Features

Antistatic&Flame-retardant Carpet tile

- It has performance that absorbs static electricity.
- The dimensions do not change much, even if an atmospheric temperature changes.
- It adopts original polypropylene, so it is resistant to dirt and color discolorion.
- It has excellent chemical-resistant such as acid and alkaline.

■ Specification

General name	Carpet tile
Dimensions	6.5mm(overall thickness) size : 500mm×500mm
Number of colors	31 colors
Packaging	16 pcs/case
Weight	4.7kg/m ² , 19kg/case

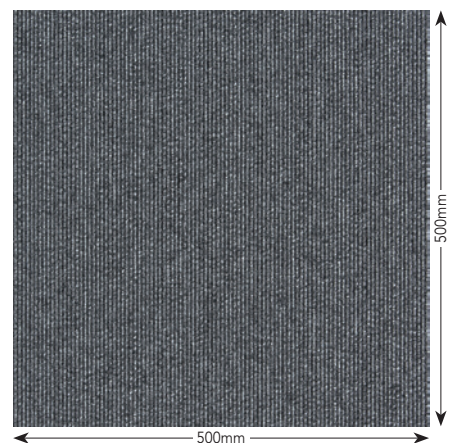

LL-1102L

■ Color variations

31colors

Pin stripe

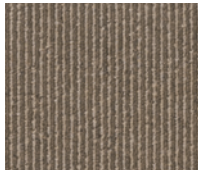

LL-1103L

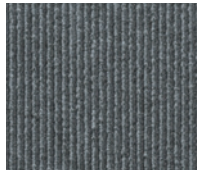

LL-1102L

Line stripe



LL-1123L



LL-1124L



LL-1122L

Random stripe



LL-1202L



LL-1203L



LL-1205L

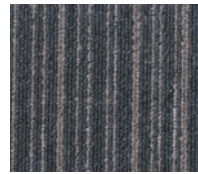

LL-1204L

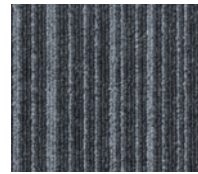

LL-1201L



LL-1206L

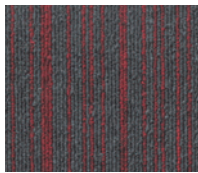

LL-1208L



LL-1207L

Plain

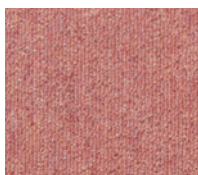

LL-1144L



LL-1168L

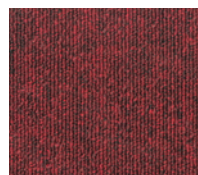

LL-1169L

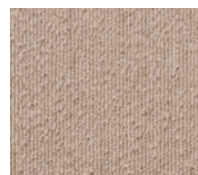

LL-1152L

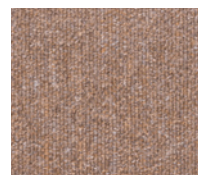

LL-1138L



LL-1135L



LL-1154L

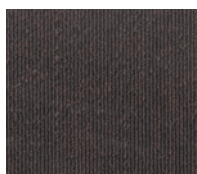

LL-1165L

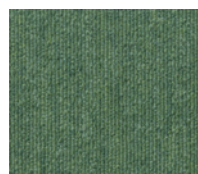

LL-1166L

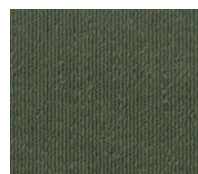

LL-1167L

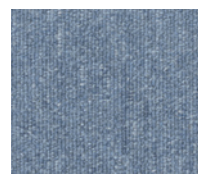

LL-1143L

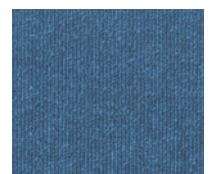

LL-1153L

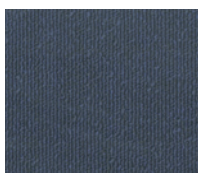

LL-1164L

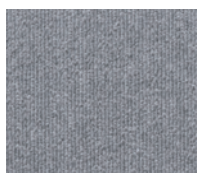

LL-1131L



LL-1132L

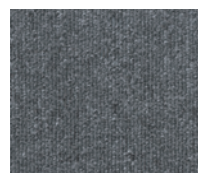

LL-1133L

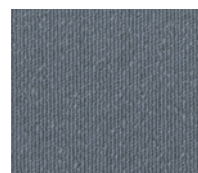

LL-1163L

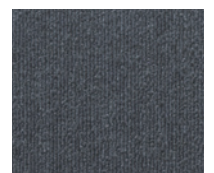

LL-1155L

LONWALL GUARD L ANTIVIRAL



GL-253

■ Features

Antiviral vinyl sheet for spandrel walls

- It reduces viral activity of enveloped viruses and non-enveloped viruses by up to 99%
- It coordinates well with CORNER GUARD S and TRIM BELT M.
- It has resistant to scratches.
- It has flexible shock absorption.
- Easy to process, so it fits easily into the installation location.

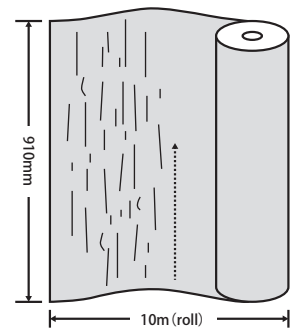

■ Specification

General name	Antiviral vinyl sheet for spandrel walls
Dimensions	0.9mm (thickness) × 910mm (width) × 10m (length)
Number of colors	11 colors
Packaging	10m/roll
Weight	1.0kg/m ² , 9kg/roll



■ Color variations

11colors

Elegant Cherry



GL-251



GL-252



GL-253

Modern Walnut



GL-351



GL-352



GL-353



GL-354

Fabric pattern



GL-451



GL-452

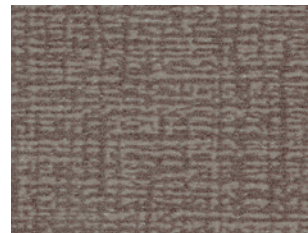

GL-453

Plain

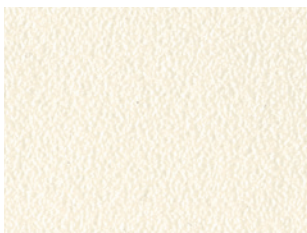

GL-551

Antiviral activity

In general terms, when a virus is inactivated, it disrupts its original growth cycle.

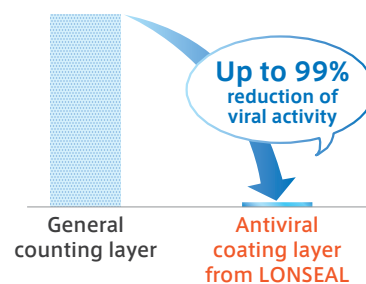
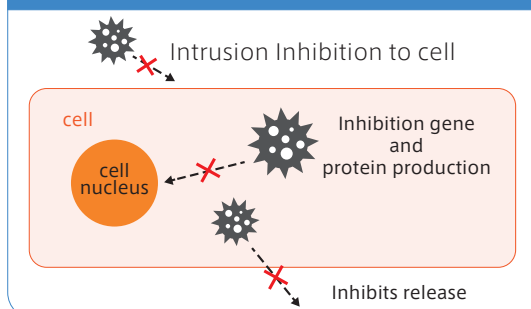

LONSEAL flooring has the uniform layer, so antiviral properties are effective in the long run.

LONWALL GUARD SP



GSP-2004

■ Features

Antibacterial&Antifungal vinyl panel for spandrel wall

- It coordinates well with CORNER GUARD S and TRIM BELT M.
- It has flexible shock absorption.
- It fits easily into the installation location.

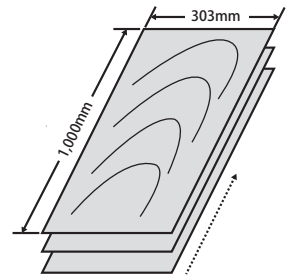

■ Specification

General name	Vinyl panel for spandrel wall
Dimensions	2.0mm (thickness) × 303mm (width) × 1m (length)
Number of colors	7 colors
Packaging	10 pcs/case
Weight	3.3kg/m, 11kg/case



■ Color variations

7colors

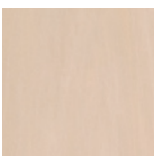

GSP-2022



GSP-2011



GSP-2004



GSP-2025



GSP-2012



GSP-2026



GSP-2007

TRIM BELT M



TVM-2023

■ Specification

General name	Soft decorative parting material for spandrel walls
Dimensions	30mm (height) × 10m (length)
Number of colors	14 colors
Packaging	10m /roll
Weight	1.25kg/case

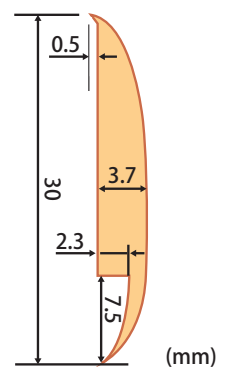

■ Color variations

14colors



TVM-2023



TVM-2025



TVM-2007



TVM-2012



TVM-2014



TVM-2016

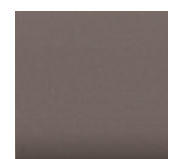

TVM-2018



TVM-2004



TVM-2026

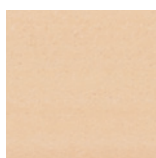

TVM-2011



TVM-2022



TVM-2015



TVM-2017

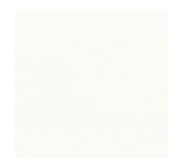

TVM-2019

CORNER GUARD S

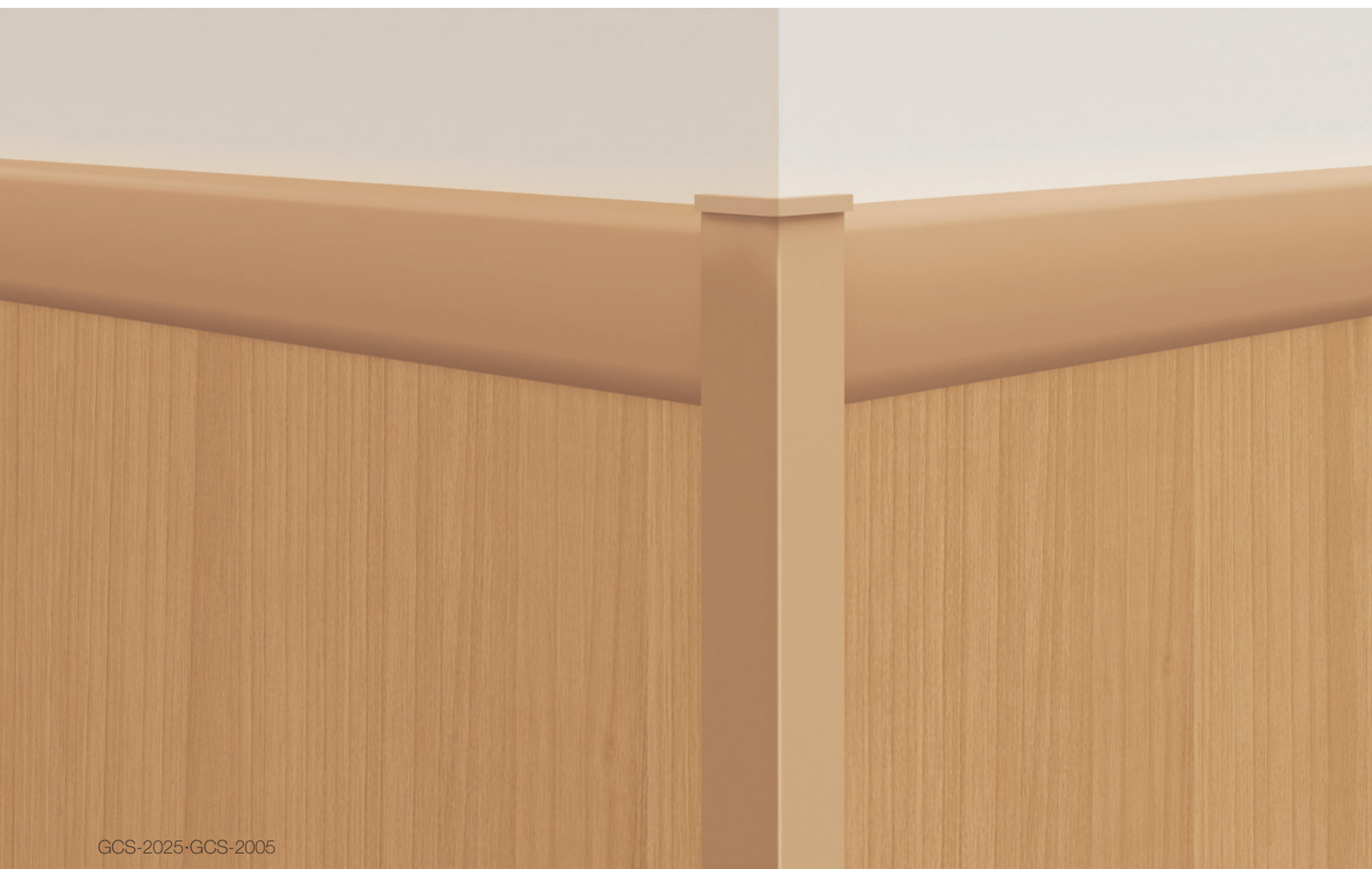

GCS-2025-GCS-2005

■ Specification

General name	Corner protective material
Dimensions	4mm (thickness) × 25mm × 25mm (width) × 1.2m (length)
Number of colors	CORNER GUARD S : 14 colors END CAP : 5 colors
Packaging	10 pcs/case
Weight	CORNER GUARD S : 4.0kg/case END CAP : 0.02kg/case

Anti-bacterial

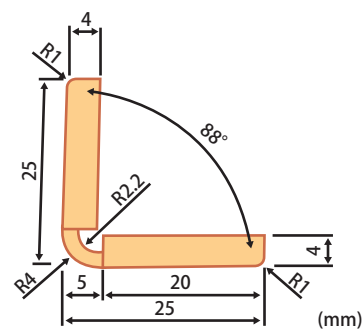

■ Color variations

14colors



GUARD CORNER S	GCS-2003	GCS-2004	GCS-2025	GCS-2006	GCS-2007	GCS-2011	GCS-2012
END CAP	GCC-2011	GCC-2005	GCC-2005	GCC-2005	GCC-2007	GCC-2011	GCC-2007



GUARD CORNER S	GCS-2013	GCS-2014	GCS-2015	GCS-2016	GCS-2017	GCS-2018	GCS-2019
END CAP	GCC-2011	GCC-203	GCC-203	GCC-2016	GCC-2005	GCC-2007	GCC-2016

PIRICAMALL S



PMS-2T

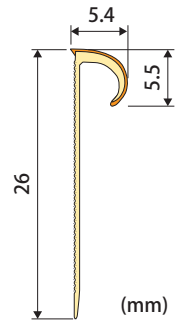

■ Specification

General name	Decorative parting material for vinyl floor sheets
Number of colors	8 colors
Packaging	2m×20 pcs/case

■ Color variations 8colors



PIRICAMALL S ACCESSORY

External&Internal corner material

- It coordinates well with PIRICAMALL S.
- They provide an exceptional professional finished irrespective of difficult installation area.

■ Specification

General name	External&Internal corner material
Packaging	100mm × 10pcs/case

•External corner material

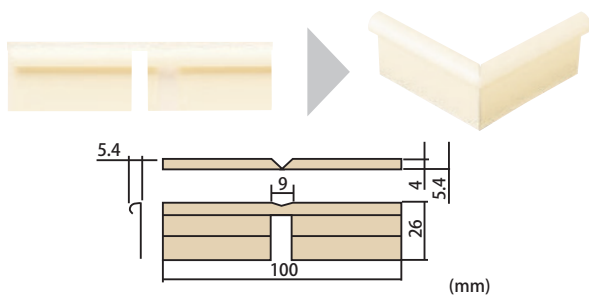

•Internal corner material

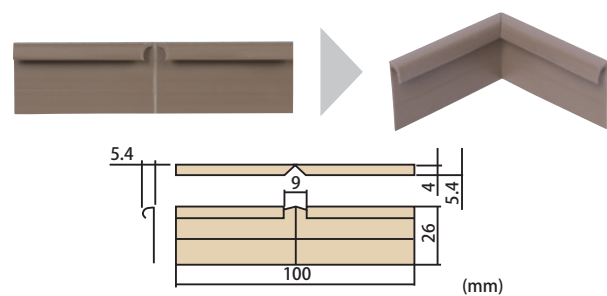

LONSOFT SKIRTING BOARD / LONSKIRTING BOARD



S-29AB

■ Specification

General name	Soft vinyl skirting board
Dimensions	60mm (height) × 914mm (length)
	75mm (height) × 914mm (length)
	100mm (height) × 914mm (length)
Number of colors	25 colors
Packaging	S-type : 25 pcs/cace
	L-type : 25 m/roll

Anti-bacterial

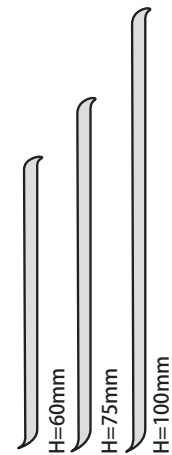

■ Color variations

25colors

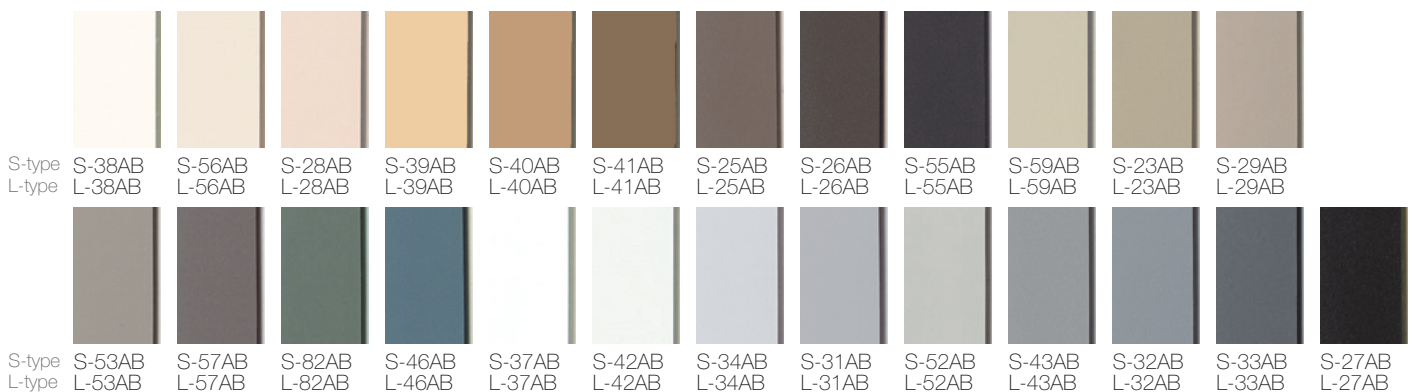

LONSKIRTING BOARD WOODY

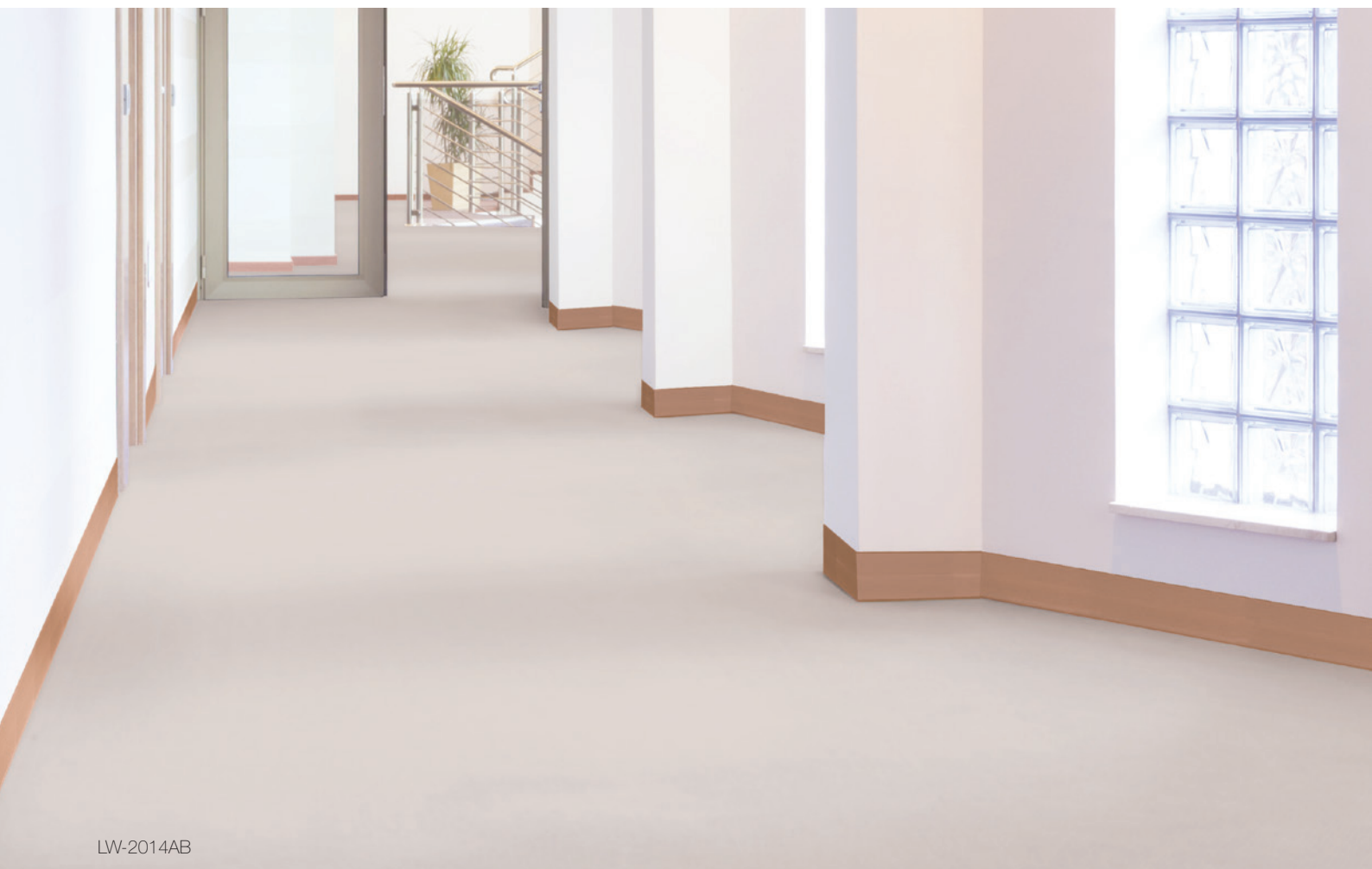

LW-2014AB

■ Specification

General name	Soft vinyl skirting board
Dimensions	60mm (height) × 25m (length)
	75mm (height) × 25m (length)
	100mm (height) × 25m (length)
Number of colors	16 colors
Packaging	25m /roll

Anti-bacterial

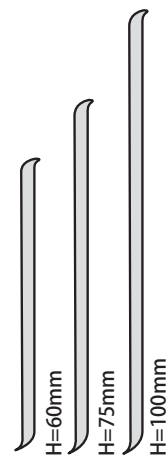

■ Color variations

16colors

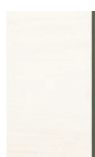

LW-2020AB



LW-2022AB

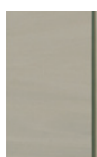

LW-2021AB



LW-2011AB



LW-2023AB



LW-2004AB



LW-2014AB



LW-2024AB



LW-2025AB



LW-2026AB



LW-2012AB



LW-2008AB



LW-2015AB



LW-2007AB



LW-2027AB



LW-2010AB

GENERAL CATALOGUE
VOL.6

LONSEAL FLOORING



 **LONSEAL CORPORATION**

6th Fl., Aste21 Bldg. 4-20-7 MIDORI, SUMIDA-KU, TOKYO, 130-0021 JAPAN

TEL:+81-3-5600-1803 FAX:+81-3-5600-1807

URL: www.lonseal.co.jp/english